

DX6 User's Manual (V1.0.2)

Index

User Notice	3
● Safety Notes	3
● Copyright	4
● Special Features	4
● Specifications	5
● Warranty & Service	5
Device Introduction	6
● Parts & Interface Introduction	6
● Standard Accessories	7
● Optional Accessories	7
● Buttons Function & Icons Description	8
Connection for Charger	9
● The Power Input Ground Cannot be Connected with the Output Ground	9
● Connection for Channel Asynchronous Mode	9
● Connection for Channel Synchronous Mode	9
Charge/Discharge Setup & Use	10
● Power Supply Setup	10
● Memory Add & Delete & Edit	11
● Run Program for Charger	12
● Program Running Status	13
● Modifying Running Program's Parameters	14
● Stop Running Program	14
● Error Messages	14
● Monitor Settings	14
● Internal Resistance Measurement	14
● USB & SD Card Use	15
● Setup of Different Batteries	15
◆ LiPo/LiIo/LiFe/LiHV/LTO/NiZn /User Setup	16
□ LiPo/LiIo/LiFe/LiHV/LTO/NiZn/User Charge Setup	16
➤ LiPo/LiIo/LiFe/LiHV/LTO/NiZn/User NON-Balance Charge Setup	16
➤ LiPo/LiIo/LiFe/LiHV/LTO/NiZn/User Balance Charge Setup	17
➤ LiPo/LiIo/LiFe/LiHV/LTO/NiZn/User Charge Advanced Setup	18
➤ LiPo/LiIo/LiFe/LiHV/LTO/NiZn/User Safety Setup	18
□ LiPo/LiIo/LiFe/LiHV/LTO/User Storage Setup	18
□ LiPo/LiIo/LiFe/LiHV/LTO/NiZn/User Discharge Setup	19
➤ Regenerative To Input	19
➤ Regenerative To Channel	19
➤ LiPo/LiIo/LiFe/LiHV/LTO/NiZn/User Discharge Advanced Setup	20
➤ LiPo/LiIo/LiFe/LiHV/LTO/NiZn/User Discharge Safety Setup	20
□ LiPo/LiIo/LiFe/LiHV/LTO/NiZn/User Cycle Setup	20
□ LiPo/LiIo/LiFe/LiHV/LTO/User Only Balance Feature	20
◆ NiMH/NiCd Battery Setup	22
□ NiMH/NiCd Battery Charge Setup	22

➤ NiMH/NiCd Battery Charge Advanced Setup	22 -
➤ NiMH/NiCd Battery Charge Safety Setup	22 -
❑ NiMH/NiCd Battery Discharge Setup	23 -
➤ NiMH/NiCd Battery Discharge Safety Setup	23 -
❑ NiMH/NiCd Battery Cycle Setup	23 -
◆ Pb Battery Setup	23 -
❑ Pb Battery Charge Setup	23 -
➤ Pb Battery Charge Advanced Setup	23 -
❑ Pb Battery Discharge Setup	24 -
❑ Pb Battery Cycle Setup	24 -
◆ Digital Power Supply Setup	24 -
Parameters Setup.....	25 -
● Parameters Setup	25 -
◆ Charger Setup	25 -
❑ Temp. & Fans Setup	25 -
❑ Beep Tone Setup	26 -
❑ LCD Setup	26 -
❑ USB PD Setup.....	26 -
❑ Output Power Setup	26 -
❑ Input Limit Setup	27 -
❑ Save & Load Configuration Setup	28 -
❑ Language Setup.....	28 -
❑ Calibration	29 -
◆ Extra Function	30 -
❑ Log Files Manage	30 -
❑ Servo Test.....	30 -
❑ Pulse Measurement	31 -
Junsi Console for DX6.....	32 -
Firmware Upgrades.....	33 -
● Firmware Upgrades via Junsi Console	33 -
● Boot Mode.....	33 -
● Firmware Upgrades via SD Card.....	33 -
Important Notes.....	34 -
● The Charging Principle for Reflex Charge Mode.....	34 -
● Power Regenerative Mode.....	34 -
● Channel Regenerative Mode	34 -
◆ Resistance or Bulbs	34 -
◆ Charging Battery.....	35 -
● Lithium Battery Extra Discharge Mode	35 -
Appendix	36 -
● Status Indication of Running Channel.....	36 -
● Status Indication of Channel Control	36 -
● Error Messages	37 -

The contents of this manual are subject to update without notice. Some function descriptions in this instruction may be different from the functions of the actual product. Please take the actual product as the standard.

User Notice

●Safety Notes

Please read the entire Manual completely before using, to make sure you can use this device properly and more safely.



DX6 is a dual port charger, but this does not mean you can charge/discharge any configuration of the two sets of batteries! You must follow these rules: two battery packs without any external electrical connections, otherwise they could permanently damage the charger or batteries. For example: when charging a 12-cell battery pack, you must split it into two separate 6-cell, and you must never charge two 6-cell battery packs in series by connecting with CH-1 and CH-2 respectively.



DX6 input power cannot have fast voltage/current fluctuations, which may cause output over current, and will damage the charger and/or the batteries and input power source in extreme cases. For example: setting the input protection current and voltage is necessary according to the specifications of the input power supply, in order not to cause power overload. Some power supply overload protection circuits will produce substantial fluctuations in the supply voltage.



WARNING! FIRE HAZARD!

NEVER USE CHARGER UNSUPERVISED!

- Batteries pose a SEVERE risk of fire if not properly handled.
- Read Entire operation manual before using charger.
- This unit may emit heat during use.
- Only operate this device in a cool ventilated area away from flammable objects.
- Failure to observe safety procedures may cause damages to property or injury.

- 1 Keep the charger away from children and pets at all times.
- 2 Never leave the charger unsupervised when charging or discharging. If you leave, disconnect the battery and switch off charger to prevent any unexpected dangers or damage.
- 3 Ensure the charger program and settings match the battery pack otherwise the battery will be damaged and a dangerous situation may arise, especially for Lithium batteries, which may cause a fire.
- 4 Do not mix batteries of different types, different capacities or from different manufacturers.
- 5 Do not disassemble the charger.
- 6 Do not place the charger or any battery on a flammable surface or near a combustible material while in use. Do not charge or discharge on a carpet, cluttered workbench, paper, plastic, vinyl, leather or wood, inside an R/C model or inside a full-sized automobile.
- 7 Never block the air intake holes and never use in a refrigerated or high temperature environment. If used in such an environment, the internal temperature protection may result in abnormal charging/discharging that could be dangerous.
- 8 Do not allow water, moisture, metal wires or other conductive material into the charger.
- 9 Never charge or discharge any battery having evidence of leaking, expansion/swelling, damaged outer cover or case, color-change or distortion.
- 10 Do not try to charge “non-rechargeable” dry cells.
- 11 Do not exceed the battery manufacturer’s suggested maximum charge rates.
- 12 Carefully follow the battery pack manufacturer’s recommendations and safety advice.

●Copyright

Copyright@ 2021 Shenzhen New Junsi Electronic Co., Ltd. All Rights Reserved.

Without prior written consent by Shenzhen New Junsi Electronic Co., Ltd, any units or individual extracts or copies of part or the entire contents of this manual, and transmission in any form is illegal and strictly prohibited.

The product described in this manual may include copyright software ownership belonging to Shenzhen New Junsi Electronic Co. Ltd and its licensee, except with the express permission from relevant rights holders, otherwise, any copying, distribution, modification, excerpt, de-compilation, disassembly, decryption, reverse engineering, lease, transfer, sub-license, as well as other acts of infringement of software copyright is strictly prohibited, but apart from the restrictions prohibited by applicable law.

●Special Features

- 13 The DX6 uses advanced Synchronous buck-boost DC/DC converter technology, high power, a high current and high-performance power conversion circuit. The maximum charge power capacity is up to 1500W, the maximum charge/discharge current of a channel is up to 32A, and two channels in Synchronous Mode are up to 50A.
- 14 Each channel supports 6s LiPo, Lilo, LiFe, LiHV, LTO and NiZn batteries, with maximum 2A balance current, and adopts a unique balance calculation of internal resistance correction. Supports 1-15s NiMH/NiCd batteries and 1-12s Pb batteries.
- 15 With digital-power mode for great protection (over-current protection, over-voltage protection, input under-voltage protection, input undercurrent protection, and etc.)
- 16 With type-c PD charging port, convenient for the user to charge mobile phones and PCs.
- 17 Intelligent fan control. Sensing internal temperature via the internal temperature sensor, to thereby control the fan speed.
- 18 Internal temperature protection. When the internal temperature exceeds the Power Reduce temperature, the output power is automatically reduced; and the charger will shut down when temperature exceeds the Shut-down temperature.
- 19 This charger can save 64 parameters sets and support the data import/export to SD card.
- 20 A 2.4" IPS LCD screen provides rich information including current, voltage, power, capacity, internal resistance, control status, time-consuming and temperature, etc.
- 21 Multi-discharge features: self-discharge, regenerative to input or discharge to another channel, and lithium battery extra expanding discharge.
- 22 Supports measurement for internal resistance of battery offline and online. Measure not only the internal resistance of the entire battery pack, but also measure the internal resistance of each cell within the lithium battery.
- 23 DX6 has protection for reversed polarity (input or output), input voltage/current, battery temperature, charging capacity, overrun time and maximum power etc.
- 24 Supports upgrading the hardware program by USB port or SD card. DX6 also supports the “Junsi Console” software and can display, plot and analyze the charge and discharge data by it.

● Specifications

Input voltage range:	9—34VDC
Maximum input current limit:	65A(Channel 45A)
Maximum charge/discharge current:	50A(Channel 32Ax2)
Maximum charge power capacity:	1500W(Channel 900Wx2)
Maximum discharge power capacity:	60W(Channel 40Wx2)
Maximum regenerative discharge power capacity:	1500W(Channel 900Wx2)
Maximum extra discharge power capacity:	1600W (Channel 900W @30V/32A)
Maximum current drain for balancing:	4A(Channel 2Ax2)
Type-C PD port:	5V/3A, 9V/2A, 12V/1.5A
Support Battery type:	LiPo, Lilo, LiFe, LiVH, LTO, NiZn, NiMH, NiCd, Pb
Net weight:	360g
Dimension:	92×112×40mm

● Warranty & Service

1. The product from the date of purchase enjoys free repair service within one year under normal conditions of use.
2. Over the warranty, if replacement parts are needed the appropriate charge for components and repair will apply.
3. During the warranty period, any of the following circumstances will not enjoy free repairs:
 - 1) Failure to use in accordance with the requirements of the user manual.
 - 2) Failure or damage caused by the unauthorized user dismantling, appending or modifying the charger.
 - 3) Failure or damage due to natural disasters, bruises, collisions and incorrect supply voltages.

Device Introduction

●Parts & Interface Introduction

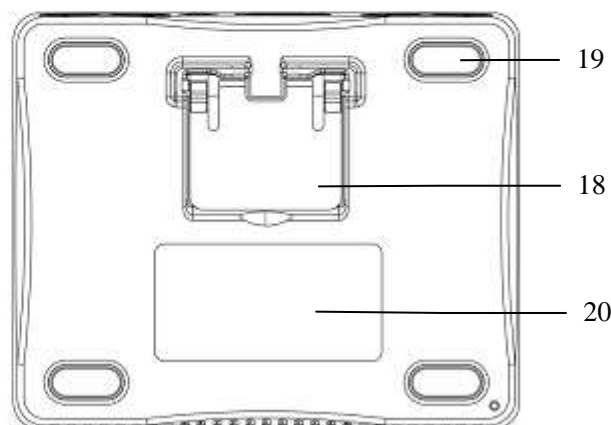
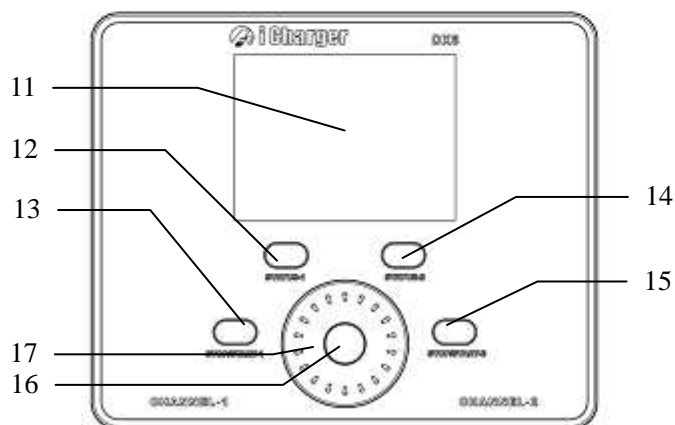
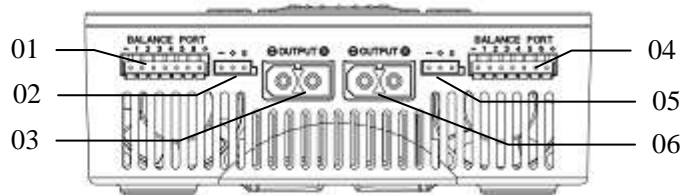
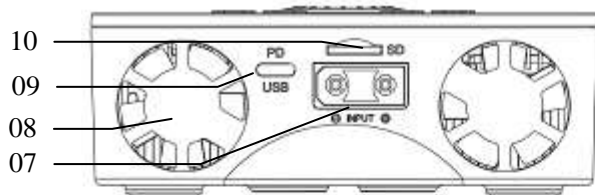

- | | | | |
|-----------------------------|------------------------------|----------------------|----------------------|
| 01)CH1 Balance port | 02) CH-1 Multi-function port | 03) CH-1 Output port | 04) CH2 Balance port |
| 05)CH-2 Multi-function port | 06)CH-2 Output port | 07) Power input port | 08)Fans |
| 09) USB Type-C & PD | 10) SD card slot | 11) LCD | 12) STATUS-1 |
| 13) STOP/START-1 | 14) STATUS-2 | 15) STOP/START-2 | 16) Round button |
| 17)Rotary switch | 18) Holder | 19) Anti slip pad | 20) Name plate |







➤ There are 3 functions for multifunctional ports: a) Connect external temperature sensor (optional) to monitor batteries temperature; b)Output for servo testing; c) Input port for pulse measurement

● **Standard Accessories**

User's manual & Software CD-ROM

cd-rom resources download: http://www.hillrc.com/cd_rom.zip

● **Optional Accessories**

Input cable	Output cable
 <p style="text-align: center; margin-top: 10px;">XT90/10AWG/600mm</p>	 <p style="text-align: center; margin-top: 10px;">XT60/12AWG/300mm</p>
Balance connector conversion board	Balance wire for balance board
 <p style="text-align: center; margin-top: 10px;">51X45.5mm</p>	 <p style="text-align: center; margin-top: 10px;">150mm</p>
Dual balance wires for balance board	Temperature sensor
 <p style="text-align: center; margin-top: 10px;">150mm</p>	 <p style="text-align: center; margin-top: 10px;">350mm</p>

●Buttons Function & Icons Description

Please refer to below chart for button functions

Symbols	Operation	Function
<●>	Click the round button	Initial interface: Enter <i>CHANNEL SELECTION</i> Other interface: Confirm function or enter submenu
<●>	Press the round button for 2 seconds	Startup interface: Enter <i>SELECT INPUT POWER SUPPLY</i> Initial interface: Enter <i>SYSTEM MENU</i> <i>MEMORY SELECTION</i> interface: Enter Program Management Menu Other interface: Save and return to Previous Menu
<⤴>	Turn the rotary switch	Turn anticlockwise: The menu scrolls up or the adjustment value becomes smaller Turn clockwise: The menu scrolls down or the adjustment value becomes larger When the round button is pressed and turned the rotary switch one time at the same time, it will be triggered automatically and continuously before releasing the pressed button.
< STATUS-x>	Click STATUS-x	Program runtime: Switch the display information page of CH-x channel
< STATUS-x>	Press STATUS-x for 2 seconds	Initial interface: Start internal resistance measurement Program runtime: The parameter change interface pops up
< STOP/START-x>	Click STOP/START-x	Initial interface: Enter <i>MEMORY SELECTION</i> ; click again to return the initial interface Program runtime: Stop running program
< STOP/START-x>	Press STOP/START-x for 2 seconds	Initial interface: Enter <i>Run Program</i> Run Program Interface: Run the selected program
< STATUS-x> + < STOP/START-x>	Press STATUS-x and STOP/START-x at the same time for 2 seconds	Initial Interface: Enter <i>MONITOR SETTINGS</i>
< STOP/START-1> + < STOP/START-2>	Press STOP/START-1 and STOP/START-2 at the same time for 2 seconds	Run Program interface: CH-1 and CH-2 run the same program

Familiarity with the icons on the interface will help you better understand the working status of the charger, as shown in following chart:

Icon	Function and Usage
	Fan status: a. Grey shows not running b. Green shows running (the higher the green shows, the faster the fan runs, and vice versa)
	SD card status: a. Grey shows the SD card is not inserted b. Green shows the SD card has been inserted and can be used normally
	USB status: a. Grey for no USB connection b. Green for USB connection c. Data transfer to PC, red dot flashes
	TYPE-C PD charge permit function

Connection for Charger

●The Power Input Ground Cannot be Connected with the Output Ground

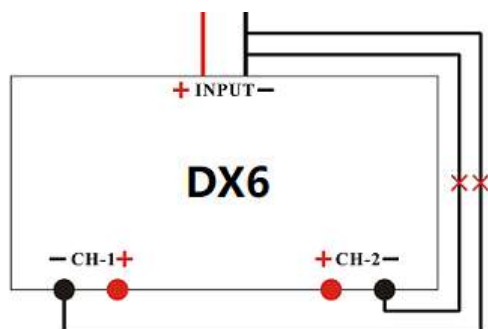

- 1. The input of power lead cannot be connected directly to the output (left picture), and the voltage of the input power supply cannot have large instantaneous fluctuations, otherwise the charger will be damaged.
- 2. Input and output voltage can NOT be exceeded rated voltage or the charger will be damaged.

●Connection for Channel Asynchronous Mode

Channel Asynchronous Mode: i.e. CH-1 and CH-2 work independently. Go to **MEMORY SETUP**→**Option**→**Channel Mode** to select **Asynchronous**.



- 1. In this mode, the two channels must not have any external electrical connection; otherwise it will damage the charger. You cannot charge with connection as shown in the left picture, the correct connection as shown in the right picture.
- 2. Please make sure CH1 and CH2 connect correct or the charger will be damaged and cause danger.

●Connection for Channel Synchronous Mode

Channel Synchronous Mode: i.e. CH-1 & CH-2 are controlled at the same time to charge/discharge one battery pack. Go to **MEMORY SETUP**→**Option**→**Channel Mode** to select **Synchronous**. In this mode, the maximum current can be up to 50A, power capacity is the sum of both channels' limits. At the same time, it is limited to the maximum power of 1600W. In the synchronous mode of balanced charge and discharge, the user can connect to any balance port or connect to two balance sockets in parallel at the same time (double the balance current).



1. The total voltage of dual-channel
2. The total current of dual-channel
3. The total capacity of dual-channel
4. Channel current & voltage difference

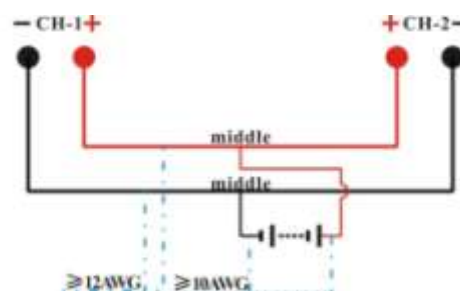

- The two channels charge one battery pack simultaneously must be connected as shown in the left picture and the two channels must work in synchronous mode, otherwise the charger will be damaged.

Charge/Discharge Setup & Use

DX6 can charge/discharge LiVH, LiPo, Lilo, LiFe, LTO, NiZn, NiMH, NiCd, Pb batteries, this manual will explain and introduce in detail the charger's features, setup and use.

●Power Supply Setup

The charger boots automatically when the power is turned on and the initial interface will display LOGO, charger relevant information, power source and message etc.

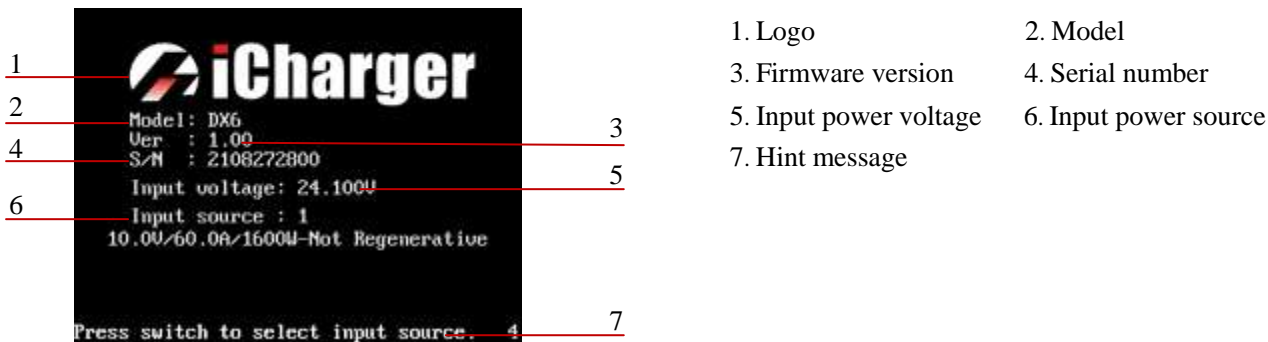

System will delay **5 seconds** after booting, during this period, long press **<●>** button to change the input source type, while pressing any other buttons to enter the initial interface.

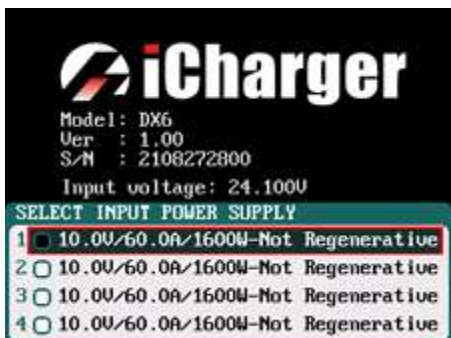

➤ There are different parameter setting of these four types of power supply, the user can set in **SYSTEM MENU → Input Limit** see details on "**Input Limit Setup**".

After selecting the input power supply, confirm and enter the initial interface.

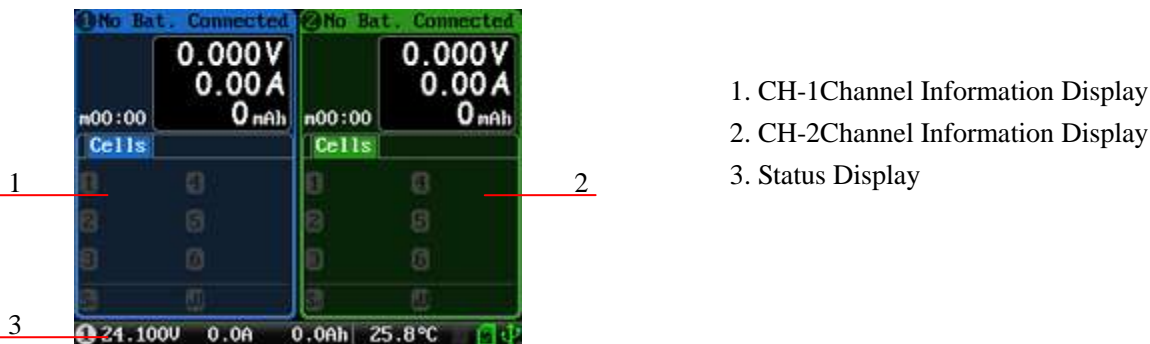

➤ When the selected input power supply does not support recovery discharge, the icon "1" in the lower left corner is gray; It is displayed in green when recovery discharge is supported.

●Memory Add & Delete & Edit

Click <STOP/START-x> button on the initial interface to pop up the **MEMORY SELECT** interface.

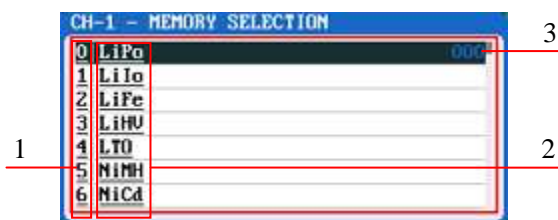

1. Memory No.
2. Memory Name
3. Running times

Except 10 built-in memories, there are 54 customized ones can be added. All memories include three types as below:

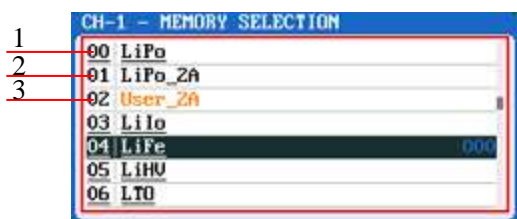

1. Built-in types: *it cannot be edited or deleted, which is in black and with underline*
2. Non-User types: *it can be edited or deleted, which is in black*
3. User types: *it can be edited or deleted, which is in orange*

Long press <●> to pop up the **MANAGE**, and click "Edit" to enter **MEMORY SETUP** to edit the memory, or click "Add" to add new memory and enter its editing interface at the same time.



➤ If the memory selected is a built-in program, "Copy From..." and "Delete" options are shown in grey as inactive status, and unable to be set.

After adding new programs or editing saved programs, the system will enter **MEMORY SETUP** interface. Users can set or modify the program on this interface.

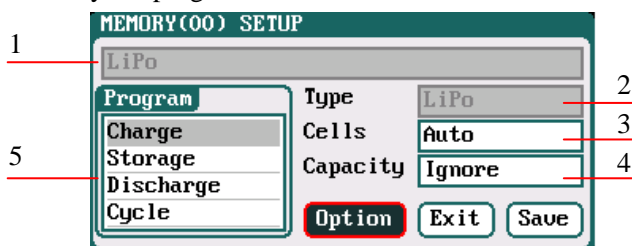

1. Memory name
2. Battery type
3. Quantity of cells
4. Battery capacity
5. Available program

➤ 1. When editing the memory name, Turn <↶> to select the character, press <●> to confirm the selected character, long press <●> to delete the character. Press <●> after editing program name to finish. If the program name is empty, the system will name it automatically.

2. If the Editing program is the built-in memory, the program name and battery type etc. parameters cannot be changed.

After setting the basic parameters of a battery, click "Option" to enter **MEMORY OPTION** interface.

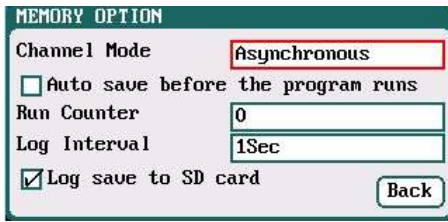

Channel Mode: *Asynchronous (default); Synchronous*
 Auto save before the program runs: *if ticking, the modified parameters will be saved automatically; default: ticking*
 Run Counter: *0-999; default: 0*
 Log Interval: *0.5-60Sec; default: 1Sec*
 Log save to SD card:

- 1. *Channel Mode* has *asynchronous, synchronous* available, see more details on [Connection for Charger](#)
- 2. If select *synchronous* mode, the maximum charge/discharge current setting will change from 32A to 50A.
- 3. If tick *Auto saves before the program runs*, the parameters set on the *Run program* will be saved automatically, and the Run Program will display “*Auto save*” (shown in the following left picture), otherwise it will display “*Don’t save!*” (shown in the following right picture); for the built-in program, the Auto save before the program runs option is ticked by default.

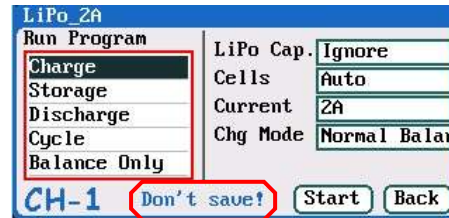
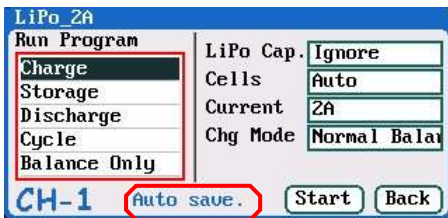

●Run Program for Charger

After selecting program on *MEMORY SELECTION*, click to enter *Run Program* interface (press <STOP/START-x> on the initial interface will enter *Run Program* from the last running program), as below:



1. Run Program Selection
2. Common Parameters Setup
3. Auto-save Hint

- 1. The revised common parameters of built-in program will be saved by default automatically after running, while the program customized by the user can be set to be saved or not in *MEMORY SETUP*→*MEMORY OPTION*→*Auto save before the program runs*.
- 2. After setting the *Cap.* value, when the Current value exceeds the certain value, the system will show a warning and alarm. The Current value of each battery type is: LiXX battery > 3C, NiMH/NiCd battery > 2C, Pb battery > 0.3C, NiZn battery > 2C.
- 3. Turn <U> to choose *Run Program*, the common parameters are in grey, which is inalterable; if needs to change, the user can long press <●>, as below:

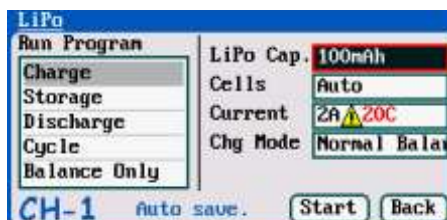

After selecting the program to run, press <●> to pop up confirmation window, as below:

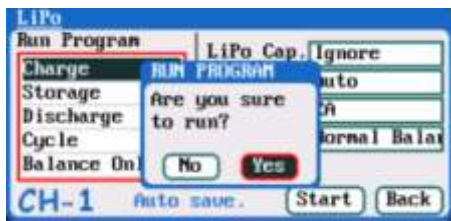

Click “Yes” to run the program, click “No” to cancel.

●Program Running Status

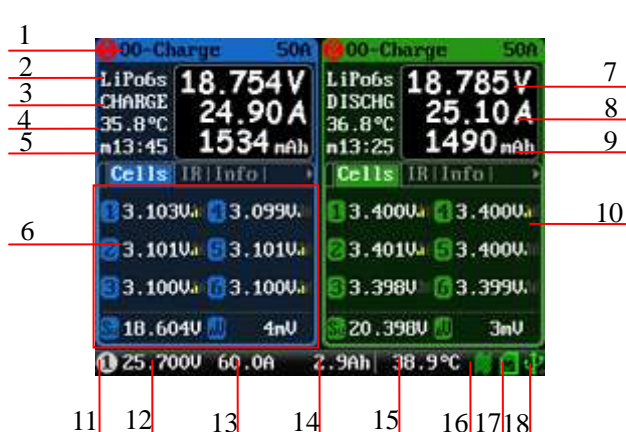

- | | |
|-----------------------------|--|
| 1. Running program name | 2. Battery type |
| 3. Running channel status | 4. Channel control status/external temperature |
| 5. Running program time | 6. Multipage information |
| 7. Charging voltage | 8. Charging current |
| 9. Charging capacity | 10. Balance strength |
| 11. Input power source type | 12. Input voltage |
| 13. Input current | 14. Input capacity |
| 15. Internal temperature | 16. Fan status |
| 17. SD card status | 18. USB status |

See details on [Status Indication of Running Channel & Status Indication of Channel Control](#)

Press <STATUS-x> button when running program to switch the multipage information displays, as below:

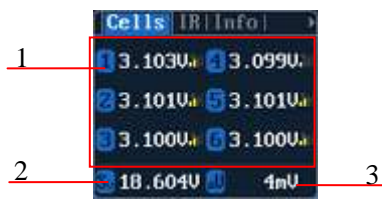

Cells voltage information

- Cells voltage
- Cells voltage sum
- Maximum cells voltage difference

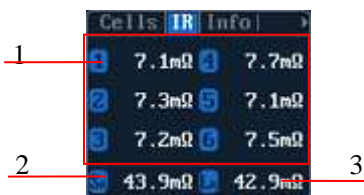

IR information

- Cells internal resistance
- Pack internal resistance
- Line resistance

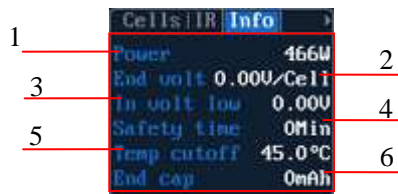

Information page

- Power
- End voltage
- Lowest input voltage
- Safety time
- Temp. cutoff
- End charge capacity

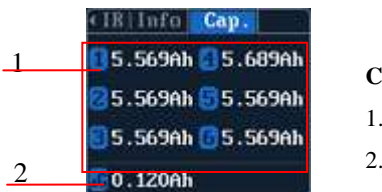

Cell Cap.

- Cell Capacity
- Maximum cells capacity difference

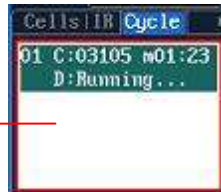

Cycle charge information

- Cycle charge status

➤ Different types of batteries and programs have different multipage information displays, see details below:

	Cells	IR	Info	Cap.	Cycle
Lipo/LiIo/LiFe/LiHV/LTO/NiZn/User	✓	✓	✓	✓	✓
NiMH/NiCd	✗	✗	✓	✗	✓
Pb	✗	✗	✓	✗	✓
Power	✗	✗	✓	✗	✗

●Modifying Running Program’s Parameters

Long press <STATUS-x> button when running program to pop up *MODIFY* interface, to modify the current and discharge voltage parameters online, as below:

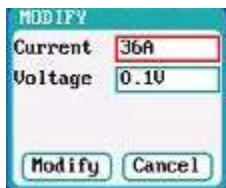

●Stop Running Program

Press <STOP/START-x> button when running program to stop running, and press <STOP/START-x> button again to return to the initial interface.

●Error Messages

During the running program, if the system detects an error, it will stop running the program on the channel immediately and pop up the red dialog box and the buzzer alarms, as below:



1. Four options of Input Sources

●Monitor Settings

Press < STATUS-x>+< STOP/START-x> at the same time for 2 seconds under initial interface, it will pop up blow window.

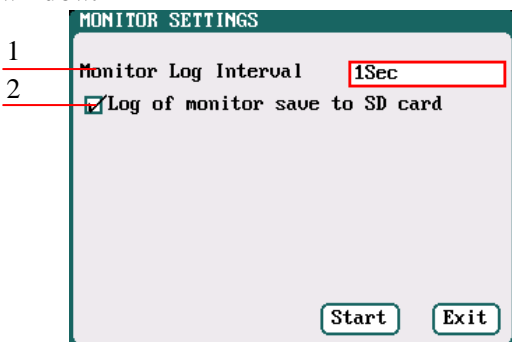

1. Monitor log intervals: 0.5-60s default: 1s

2. Log of monitor save to SD automatically:

If checked, the monitoring log will be automatically saved to the SD card.

Press “Start” button to start Monitor interface

●Internal Resistance Measurement

DX6 can measure the internal resistance of the battery but the data accuracy is not high. It’s greatly affected by the number of battery strings, detection current and other factors. During charging or discharging, it automatically started the internal resistance measurement every 1 minute

At the initial interface, long press < STATUS-x> and start measure internal resistance manually.

●USB & SD Card Use

DX6 is the HID device of USB, supported by windows system directly, dispense with installing additional drivers. The USB icon will light up on the lower right corner of the screen when the DX6 connects with computer normally.

The SD icon will light up on the lower right corner of the screen when the SD card is inserted. If DX6 connects with the USB without running a program, the new added U disk can be found on the "My Computer" of the PC, and can operate the file. Log files are stored in the X: \Junsi \ DX6 \Log folder and *config*. files are stored in the X:\Junsi\DX6\System folder.

- 1. The file system of SD card must be FAT, FAT32 or exFAT.
- 2. Data in SD card needs to be backed up in case it is lost.

●Setup of Different Batteries

The following form shows specific range of different batteries:

	Nominal voltage	Charge voltage	Discharge voltage	Storage voltage	Support Cells	Support Balance
LiPo	3.7V	3.85V--4.35V Default: 4.20V	3.00V—4.10V Default: 3.50V	3.70V—3.90V Default: 3.85V	1-6s	Yes
Lilo	3.6V	3.75V—4.35V Default: 4.10V	2.50V—4.00V Default: 3.50V	3.60V—3.80V Default: 3.75V	1-6s	Yes
LiFe	3.3V	3.30V—3.80V Default: 3.60V	2.00V—3.50V Default: 2.50V	3.10V—3.40V Default: 3.30V	1-6s	Yes
LiHV	3.8V	3.90V—4.45V Default: 4.35V	3.00V—4.25V Default: 3.60V	3.75V—4.10V Default: 3.90V	1-6s	Yes
LTO	2.4V	2.50V—3.10V Default: 2.85V	1.50V—2.90V Default: 1.80V	2.40V—2.60V Default: 2.50V	1-6s	Yes
NiZn	1.6V	1.20V—2.00V Default: 1.90V	0.90V—1.60V Default: 1.10V	-----	1-6s	Yes
User	-----	1.00V—4.80V Default: 1.00V	0.50V—4.50V Default: 1.00V	1.00V—4.50V Default: 1.00V	1-6s	Yes
Pb	2.0V	2.00V—2.60V Default: 2.40V	1.50V—2.40V Default: 1.80V	-----	1-12s	No
NiCd/NiMh	1.2V	-----	-----	-----	1-15s	No

◆ LiPo/LiIo/LiFe/LiHV/LTO/NiZn /User Setup

After adding a program, it will switch to LiPo/LiIo/LiFe/LiHV/LTO/NiZn/User battery in *Type* option on the **MEMORY SETUP** interface, and set the number of *cells* and *capacity*, if there is no setting for the number of cells, the charger will set *Auto* by default. After editing all parameters for the program, click "Save" to save and return to the previous interface.

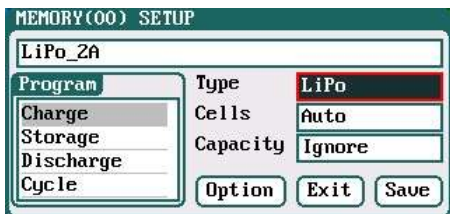

Cells: *Auto(default), 1-6s*
Capacity: *Ignore(default),50-999900mAh*

➤ As shown in the above picture, there are Charge, Storage, Discharge, Cycle and Balance Only for LiPo/LiIo/LiFe/LiHV/LTO/User., while Charger, Discharge and Cycle for Nizn user only.

□ LiPo/LiIo/LiFe/LiHV/LTO/NiZn/User Charge Setup

Select **Program**→**Charge** to enter **Charge** setup interface.

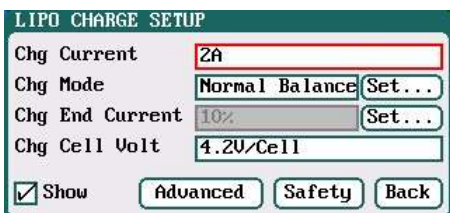

Chg Current: *0.05A-32A; default: 2A*
Chg Mode: *Slow Balance, Normal Balance(default), Fast Balance, User Balance, Not Balance*
Chg End Current: *1%-50%; default: 10%*
Chg Cell Volt:
LiPo 3.85V/Cell-4.35V/Cell; default: 4.2V/Cell
LiIo 3.75V/Cell-4.35V/Cell; default: 4.1V/Cell
LiFe 3.30V/Cell-3.80V/Cell; default: 3.6V/Cell
LiHV 3.90V/Cell-4.40V/Cell; default: 4.35V/Cell
LTO 2.50V/Cell-3.10V/Cell; default: 2.85V/Cell
NiZn 1.20V/Cell-2.00V/Cell; default: 1.90V/Cell
User 1.00V/Cell-4.80V/Cell; default: 1.00V/Cell

- 1. When the value of charge cells voltage exceeds the recommended value (LiPo 4.2V, LiIo 4.1V, LiFe 3.6V, LTO 2.85V), the charger will display a warning and alarm. As long as the user changes the values, the battery types and cells voltage value on the main charging interface will be displayed alternately.
- 2. For the setting process for all program in this manual, tick **Show** to display the setting program on **MEMORY SETUP** (shown in the following picture), and vice versa; the built-in memory is ticked by default.

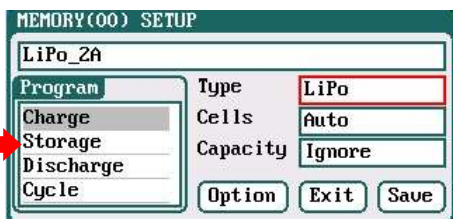

☉ LiPo/LiIo/LiFe/LiHV/LTO/NiZn/User NON-Balance Charge Setup

When switch to *Not Balance* on *Chg Mode*, only *Chg End Current* is available for charging end condition, and “**Set ...**” behind *Chg Mode* and *Chg End Current* are inactive.

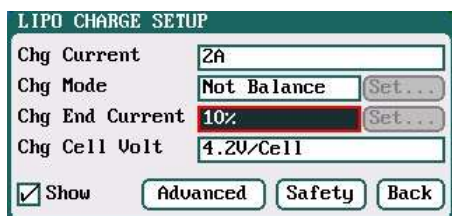

- The charger first charges with constant current (CC) according to the user setting, then turns to constant voltage (CV) when the charging voltage reaches the peak point. In the CV phase the current gradually falls, and the charger will terminate charging when the current falls below the percentage of the configured charge current.

For example: the default value of Chg Current is 2A, and the default value of Chg End Current is 10%

$$\text{Chg End Current} = 2\text{A} * 10\% = 0.2\text{A}$$

Therefore it stops charging when the charging current reduces to 0.2A.

⊙ LiPo/LiIo/LiFe/LiHV/LTO/NiZn/User Balance Charge Setup

Switch to *Slow Balance*, *Normal Balance*, *Fast Balance* or *User Balance* on **Chg Mode** as the balance charge mode, and "Set ..." button will be available, click it to enter *Balance* mode setup interface.

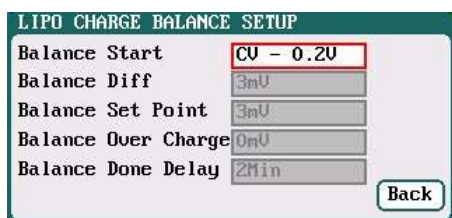

Balance Start : CV, CV-0.1V—1V, Always

Default: CV-0.2

If the balance charge voltage is 4.2V, Balance Start set to CV-0.2V; therefore the charger will start to balance the battery cells when the voltage reaches to 4.2V-0.2V=4V

- On Balance mode, the charger will monitor the voltage of individual cells to control it within the Chg Cell Volt and equalize the voltage in all cells, to avoid some cell voltage over-charged or not full. When selecting Balance mode, the balance port of charger or balance board must be connected with battery except for connecting 1S battery.

When switch to *User Balance* mode on **Chg Mode**; the *Balance Diff*, *Balance Set Point*, *Balance Over Charge* and *Balance Done Delay* are available, after setting, click "Back" to return to the previous interface.

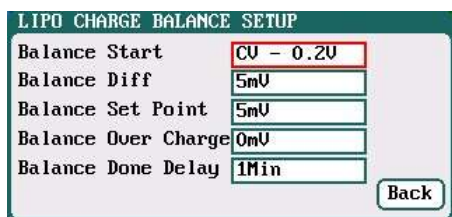

Balance Diff: 1mV-10mV; default:5mV

Balance Set Point: 1mV-50mV; default:5mV

Balance Over Charge: 0mV-50mV; default:0mV

Balance Done Delay: 0Min-20Min; default:1Min

- If *Balance Diff* value is lower, the voltage difference between individual cells will be lower and the balancing will take more time before the program ends.

If *Balance Set Point* value is lower, the battery will be closer to the setting cut-off voltage and the time taken will be longer before the program ends.

Balance Over Charge, the maximum overcharge compensation voltage acts as accelerated charge, and the larger the value, the more obvious the accelerated charge.

For example: Charge Lipo with Vstd, set Balance Over charge to Vboc, the cell's internal Resistance detected is Ri, when the charge current is Ia, the actual CV value of cells is Va

$$\begin{aligned} &\text{IF } R_i * I_a > V_{boc} \text{ THEN} \\ &\quad V_a = V_{std} + V_{boc} \\ &\text{ELSE} \\ &\quad V_a = V_{std} + R_i * I_a \end{aligned}$$

Please set this parameter after understanding fully, or keep the default value at 0.

The value of *Balance Done Delay* is larger; the battery is closer to the setting cut-off voltage when the program ends.
Switch to *Balance charge mode* on *Chg Mode*, and click "Set..." behind *Chg End Current* to enter *CHARGE BALANCE End SETUP* interface for setting.

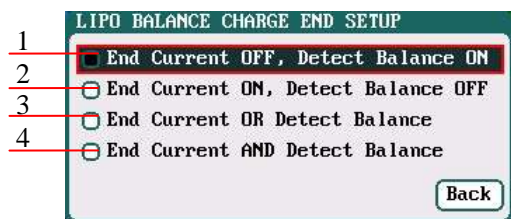

1. The charger will stop balance charge if detects the Balance condition is met, and the End Current condition is invalid
2. The charger will stop balance charge if detects the End Current condition is met, and the Balance condition is invalid
3. The charger will stop balance charge if detects the End Current condition or the Balance condition is met
4. The charger will stop balance charge if detects the End Current condition and the Balance condition are *met*

➤ LiPo/LiIo/LiFe/LiHV/LTO/NiZn/User Charge Advanced Setup

Click "Advance" to enter LiPo/LiIo/LiFe *ADVANCED SETUP*, after setting, click "Back" to return to the previous interface.

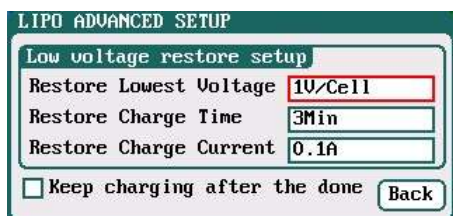

Restore Lowest Voltage: 0.5V/Cell-2.5V/Cell; Default: 1V/Cell
 Restore Charge Time: 1Min-5Min; default: 3Min
 Restore Charge Current: 0.02A-0.5A; default: 0.1A

- 1. When charging the over-discharged battery, the charger will detect if the cell voltage is larger than the restore voltage, if larger, it will pre-charge the battery with restore current, if within the setting restore time, the cell voltage rises to the normal value then it will turn to the charging program; otherwise it will stop running.
- 2. After charging, the battery may not be completely charged; tick "*Keep charging after the done*" to charge the battery with smaller current when charging ends.

➤ LiPo/LiIo/LiFe/LiHV/LTO/NiZn/User Safety Setup

Click "Safety" to enter *CHARGE SAFETY SETUP*.

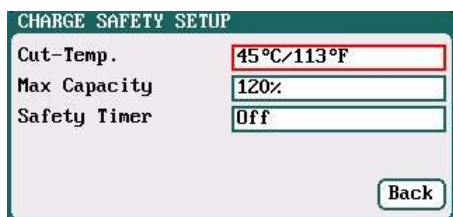

Cut-Temp: 20°C-80°C; default: 45°C
 Max Capacity: 50%-200%; default: 120%
 Safety Timer: 1Min-9999Min; default: off

- *Cut-Temp.* is the maximum safety temperature of the battery. If the external temperature sensor detects the set value, the program will stop running in order to protect the battery from being damaged by high temperature.

□ LiPo/LiIo/LiFe/LiHV/LTO/User Storage Setup

This mode is for storing LiPo/LiIo/LiFe battery that will not to be used for an extended period. The charger determines whether to charge or discharge the battery based on the configured target voltage. If the battery voltage exceeds the target storage voltage it will start to discharge, while lower than the target storage voltage it will start to charge.

Select *Program*→*Storage* to enter *Storage* setup interface.

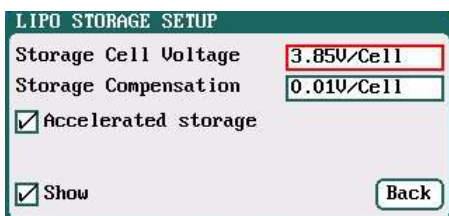

Storage Cell Voltage:

- LiPo* 3.7V/Cell-3.9V/Cell; default: 3.85V/Cell
- LiIo* 3.6V/Cell-3.8V/Cell; default: 3.75V/Cell
- LiFe* 3.1V/Cell-3.4V/Cell; default: 3.30V/Cell
- LiHV* 3.75V/Cell-4.1V/Cell; default: 3.9V/Cell
- LTO* 2.4V/Cell-2.6V/Cell; default: 2.5V/Cell
- User* 1.00V/Cell-4.5V/Cell; default: 1.0V/Cell

Storage Compensation:

0V/Cell-0.2V/Cell; Default: 0.01V/Cell

- 1. **Accelerated storage:** accelerated storage via internal resistance correction. Tick **Accelerated storage** to activate accelerated storage.
- 2. **Storage Compensation** is the compensation for the battery voltage fallback:
 - for storage charge, the actual storage voltage=Storage Cell Voltage + Storage Compensation;
 - for storage discharge, the actual storage voltage=Storage Cell Voltage - Storage Compensation.

LiPo/LiIo/LiFe/LiHV/LTO/NiZn/User Discharge Setup

Select **Program**→**Discharge** to enter **Discharge setup** interface.

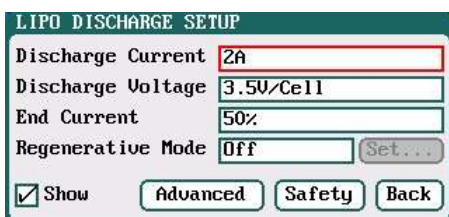

Discharge Current: 0.05A-32A; default: 2A

Discharge Voltage:

- LiPo* 3V/Cell-4.1V/Cell; default: 3.5V/Cell
- LiIo* 2.5V/Cell-4.0V/Cell; default: 3.5V/Cell
- LiFe* 2V/Cell-3.5V/Cell; default: 2.5V/Cell
- LiHV* 3V/Cell-4.25V/Cell; default: 3.6V/Cell
- LTO* 1.5V/Cell-2.9V/Cell; default: 1.8V/Cell
- NiZn* 0.9V/Cell-1.6V/Cell; default: 1.1V/Cell
- User* 0.5V/Cell-4.5V/Cell; default: 1.0V/Cell

End Current: 1%-100%; default: 50%

Regenerative Mode:

OFF (default), To input, To channel

- 1. The charger first discharges with constant current (CC) according to the user setting then turns to constant voltage (CV) when it reaches the discharge voltage. In the CV phase the current gradually falls, and the charger will terminate discharging when the current falls below the percentage of the configured discharge current.
- 2. **Regenerative mode** has three available settings: **OFF**, **To input**, **To channel**, see more details on [Important Notes](#).

Regenerative To Input

When selecting to **To input** on **Regenerative Mode**, the energy discharged by the charger to the battery will be recovered to the input port. For parameter settings, see [Input Limit Setup](#)

Regenerative To Channel

When selecting to **To channel** on **Regenerative Mode**, "Set..." button changes from inactive to its operational status, and click to enter **CHANNEL REGENERATIVE SETUP** interface.

LIPO CHANNEL REGENERATIVE SETUP

Channel Join: Resistance or bulbs

Voltage Limit: 12V

Current Limit: 1A

Back

Channel Join: *Resistance or bulbs (default)*

Charging battery

Voltage Limit: *2V-28V; default: 12V*

Current Limit: *0.05A-32A; default: 1A*

LIPO CHANNEL REGENERATIVE SETUP

Channel Join: Charging battery

Voltage Limit: 12V

Current Limit: 1A

Back

- 1. For example, a 12V/60W bulb as the load of To Channel, it should set Voltage Limit =12V; Current Limit=60/12=5A.
- 2. When the battery as the load of To Channel, Voltage Limit and Current Limit are not settable, see details on [Channel Regenerative Mode](#).

➤LiPo/LiIo/LiFe/LiHV/LTO/NiZn/User Discharge Advanced Setup

Click "Advanced" to enter *DISCHARGE ADVANCED SETUP* interface.

LIPO DISCHARGE ADVANCED SETUP

Extra Discharge Enable

Balance Enable

Back

- 1. Tick *Extra Discharge Enable* to activate discharge enable, see more details on [Lithium Battery Extra Discharge Mode](#).
- 2. Tick *Balance Enable* to activate balance discharge; when discharge enters the CV phase, it starts to balance the cell voltages.

➤LiPo/LiIo/LiFe/LiHV/LTO/NiZn/User Discharge Safety Setup

Click "Safety" to enter *DISCHARGE SAFETY SETUP* interface.

CHARGE SAFETY SETUP

Cut-Temp.: 45°C/113°F

Max Capacity: 90%

Safety Timer: Off

Back

Cut-Temp: *20°C-80°C; default: 45°C*

Max Capacity: *50%-200%; default: 90%*

Safety Timer: *1Min-9999Min; default: off*

☐LiPo/LiIo/LiFe/LiHV/LTO/NiZn/User Cycle Setup

Select *Program*→*Cycle* to enter *CYCLE SETUP* interface.

LIPO CYCLE SETUP

Cycle Mode: CHG->DCHG

Cycle Count: 3

Delay Time: 3Min

Show

Back

Cycle Mode: *CHG→DCHG(default),DCHG→CHG,*

CHG→DCHG CHG, DCHG→CHG DCHG,

CHG→DCHG STO, DCHG→CHG STO

Cycle Count: *1-99; default: 3*

Delay Time: *0Min-9999Min; default: 3Min*

☐LiPo/LiIo/LiFe/LiHV/LTO/User Only Balance Feature

Select *Program*→*Balance Only* to enter *Balance Only* setup interface.



➤ *Balance Only* is the program only to equalize the individual cells through balance port to reduce the voltage difference.

◆ NiMH/NiCd Battery Setup

After adding a program, it will switch to NiMH/NiCd battery in *Type* option on the **MEMORY SETUP** interface. Set the *Capacity*, the number of cells for NiMH/NiCd battery cannot be set, and the charger sets *Auto* by default, after editing all parameters for the program, click "Save" to save and return to the previous interface.

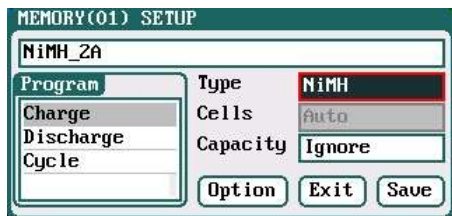

Capacity: *Ignore (default), 50-999900mAh*

As shown in above picture, the program of NiMH, NiCd has the following modes: *Charge, Discharge* and *Cycle*.

□ NiMH/NiCd Battery Charge Setup

Select **Program**→**Charge** to enter **CHARGE SETUP** interface.



Chg Current: *0.05A-32A; default: 2A*

Chg Mode: *Normal (default), Reflex*

➤ Charge Mode has *Normal* and *Reflex* modes available; use reflex mode to charge the battery, it can reduce the heat in the battery; please see charging principle on [Important Notes](#).

⊕ NiMH/NiCd Battery Charge Advanced Setup

Click "Advanced" to enter **CHARGE OPTION SETUP** interface.

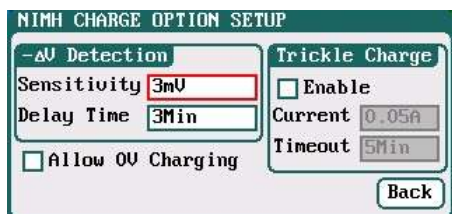

Sensitivity: *1mV-20mV; default: 3mV(NiMH), 5mV(NiCd)*

Delay time: *0Min-20Min; default: 3Min*

➤ For the over-discharged NiMH/NiCd battery, the voltage may be close to 0V, tick "**Allow 0V Charging**" to allow charge with 0V.

Tick **Trickle Enable**→**Enable** to activate trickle charge and set the parameters.



Trickle current: *0.02A-1A; default: 0.05A*

Trickle timeout: *1Min-999Min; default: 5Min*

➤ Tick **Enable** to activate trickle charge. Trickle charge means when the standard charge is completed, the charger will charge the battery with the setting trickle **Current** until the setting trickle **Timeout**, then to stop the charging process.

⊕ NiMH/NiCd Battery Charge Safety Setup

Click "Safety" to enter **CHARGE SAFETY SETU** interface,

See details about setting on [LiPo/LiIo/LiFe/LiHV/LTO/NiZn/User Charge Safety Setup](#).

❑ NiMH/NiCd Battery Discharge Setup

Select **Program**→**Discharge** to enter **DISCHARGE SETUP** interface.

NIMH DISCHARGE SETUP	
Discharge Current	2A
Discharge Voltage	0.8V
End Current	50%
Regenerative Mode	Off
<input checked="" type="checkbox"/> Show	
<input type="button" value="Safety"/> <input type="button" value="Back"/>	

Discharge Current: 0.05A-32A; default: 2A
 Discharge Voltage: 0.1V- 35V; default: 0.8V
 End Current: 1%-100%; default: 50%
 Regenerative Mode: OFF (default), To input, To channel

➤ NiMH/NiCd Battery Discharge Safety Setup

Click "Safety" to enter **DISCHARGE SAFETY SETUP** interface.

See details about setting on [LiPo/LiIo/LiFe/LiHV/LTO/NiZn/User Discharge Safety Setup](#).

❑ NiMH/NiCd Battery Cycle Setup

Select **Program**→**Cycle** to enter **CYCLE SETUP** interface.

See details about setting on [LiPo/LiIo/LiFe/LiHV/LTO/NiZn/User Cycle Setup](#)

◆ Pb Battery Setup

After adding program, it will switch to Pb battery in **Type** option on the **MEMORY SETUP** interface. Set the number of **cells** and **capacity**, after editing all parameters for program, click "**Save**" to save and return to the previous interface.

MEMORY(02) SETUP	
Pb6s_2A	
Program	Type
Charge	Pb
Discharge	Cells
Cycle	12.0V (6S)
	Capacity
	Ignore
<input type="button" value="Option"/> <input type="button" value="Exit"/> <input type="button" value="Save"/>	

Cells: 2 -15S; default: 6S
 Capacity: Ignore(default),50-999900mAh

As shown in above picture, the program of Pb battery has the following modes: *Charge*, *Discharge* and *Cycle*.

❑ Pb Battery Charge Setup

Select **Program**→**Charge** to enter **PB CHARGE SETUP** interface.

PB CHARGE SETUP	
Chg Current	2A
Chg Mode	Normal
Chg End Current	10%
Chg Cell Volt	2.4V/Cell
<input checked="" type="checkbox"/> Show	
<input type="button" value="Advanced"/> <input type="button" value="Safety"/> <input type="button" value="Back"/>	

Chg Current: 0.05A-32A; default: 2A
 Chg Mode: Normal (default), Reflex
 Chg End Current: 1%-50%; default: 10%
 Chg Cell Volt: 2V/Cell-2.6V/Cell; Default: 2.4V/Cell

- 1. The charger first charges with constant current (CC) according to the user setting then turns to constant voltage (CV) when the charging voltage reaches the peak point. In the CV phase the current gradually falls, and the charger will terminate charging when the current falls below the percentage of the configured charge current.
- 2. Charge mode has Normal, Reflex two modes available, about the Reflex mode (Reflex) please see [Important Notes](#).

➤ Pb Battery Charge Advanced Setup

Click "Advanced" to enter **PB ADVANCED SETUP** interface,

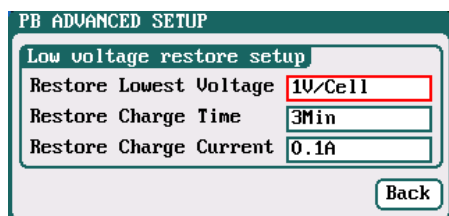

Restore Lowest Voltage:
0.5V/Cell-2.5V/Cell; default: 1V/Cell

Restore Charge Time: *1Min-5Min; default: 3Min*

Restore Charge Current: *0.02A-0.5A; default: 0.1A*

➤ When charging the over-discharged battery, the charger will detect if the cell voltage is larger than the **Restore Lowest Voltage**, if larger, it will pre-charge the battery with **Restore Charge Current**, if within the setting **Restore Charge Time**, the cell voltage rises to the normal value then it will turn to the charging program; otherwise it will stop running.

❑ Pb Battery Discharge Setup

Select **Program**→**Discharge** to enter **PB DISCHARGE SETUP** interface.
See details about setting on LiPo/LiIo/LiFe/LiHV/LTO/NiZn/User Discharge Setup.

❑ Pb Battery Cycle Setup

Select **Program**→**Cycle** to enter **PB CYCLE SETUP** interface.
See details about setting on LiPo/LiIo/LiFe/LiHV/LTO/NiZn/User Cycle Setup.

◆ Digital Power Supply Setup

DX6 can be an adjustable and stabilized digital power supply, setting as below:
After adding program, it will switch to **Power** in **Type** option on the **MEMORY SETUP** interface. After editing all parameters for program, click "**Save**" to save and return to the previous interface.

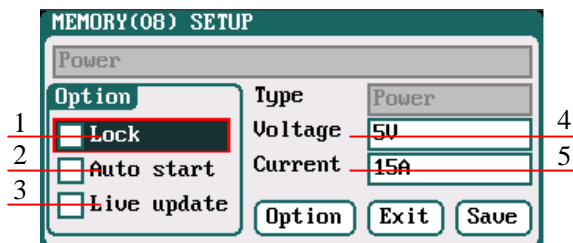

- 1.Lock:
The parameters can't be modified when running program
- 2.Auto start: *If run this program when power off, then the program will run automatically when power on again*
- 3.Live update: *The modified parameters will take effect when running program*
- 4.Voltage: *2V- 28V; default: 5V*
- 5.Current: *1A-32A; default: 15A*

➤ **Power** mode has a faster output adjustment rate (about 100kHz) than other output modes. In the case of input voltage change and load change, it can better keep the voltage output constant; Overcurrent protection is also more rapid.

Parameters Setup

●Parameters Setup

Press <↓> button on the initial interface to enter the *SYSTEM MENU* interface, setting and testing of the system parameters, storage and servo can be completed on this interface.

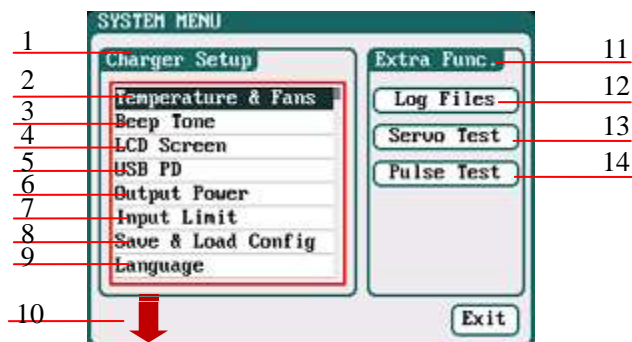

1. Charger Setup Menu

- | | |
|-----------------------------------|----------------|
| 2.Temp. & Fans Setup | 3.Beep Tone |
| 4. LCD Screen | 5.USB PD |
| 6. Output Power Setup | 7.Input Limit |
| 8.Save & Load Configuration Setup | |
| 9.Language Setup | |
| 10. Calibration | |
| 11.Extra- Function | |
| 12.Log Files Manage | 13. Servo Test |
| 14. Pulse Test | |

◆Charger Setup

After setting all parameters, click “Save” to save and return to the previous interface.

□Temp. & Fans Setup

Select *SYSTEM MENU*→*Temperature&Fans* to enter the setup interface

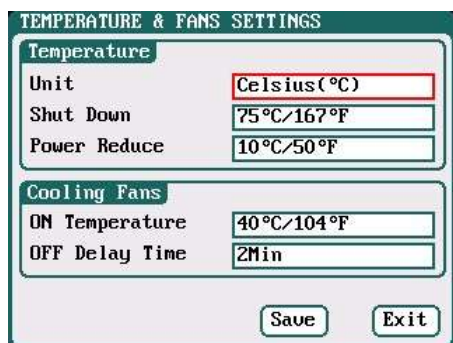

- 1: Temperature:
 - Unit: *Celsius (default), Fahrenheit*
 - Shut Down: *65°C-80°C; default: 80°C*
 - Power Reduce: *-5°C-20°C; default: -10°C*
- 2: Cooling Fans:
 - ON Temperature: *30°C-50°C; default: 40°C*
 - OFF Delay Time: *0Min-10Min; default: 2Min*

- When the charger’s internal temperature reaches the *ON Temperature*, the fan will start automatically to dissipate heat, and adjust speed automatically depends on the temperature increasing or decreasing. When the temperature exceeds the *Power Reduce* temperature, the charger will stop increasing (temp. shown in orange) by reducing the highest power limit. When the temperature reaches *Shut Down* temperature, the charger will shut down. [When temp. >*Shut Down*-3, the temperature is shown flashing in red]. When the temperature is lower to the *ON Temperature*, the fan will keep running within the setting time of *OFF Delay Time*.

□ Beep Tone Setup

Select **SYSTEM MENU**→**Beep Tone** to enter the setup interface.

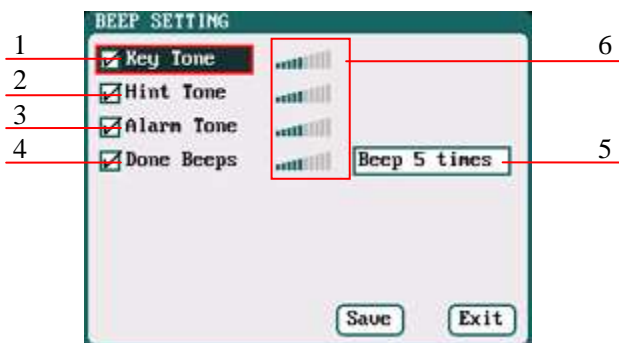

- | | |
|---------------|---------------|
| 1. Key Tone | 2. Hint Tone |
| 3. Alarm Tone | 4. Done Beeps |
5. Volume adjustment display
Beep 5times (default)
Beep 30second
Beep 3minutes
Beep always
6. Program Done Beep Tones Selection

➤ Tick the appropriate tone, and then go to Volume adjustment bar to adjust the volume; If the beep tone is not ticked the corresponding volume adjustment shows inactive; Done Beeps have many styles available, as shown in sequence number 5 above.

□ LCD Setup

Select **SYSTEM MENU**→**LCD Screen** to enter the setup interface.

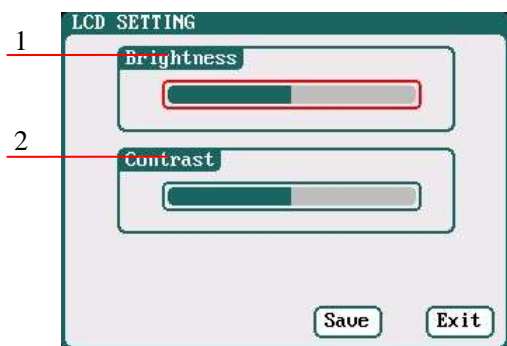

1. Brightness adjustment
2. Contrast adjustment

□ USB PD Setup

Select **SYSTEM MENU**→**USB PD** to enter the setup interface.



1. USB PD Off, Communication On
2. USB PD On, Communication off

□ Output Power Setup

Select **SYSTEM MENU**→**Output Power** to enter the setup interface.

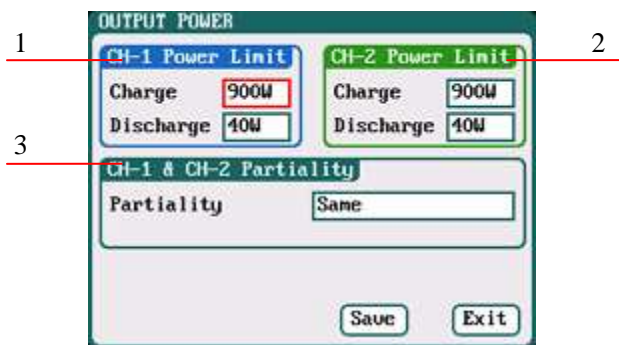

- 1/2. CH-1/CH-2 Output Power Setup
 Charge: *Maximum Power Limit for charge*
 5W-900W; default: 900W
 Discharge: *Maximum Power Limit for discharge*
 5W-40W; default: 40W
3. Partiality: *Same (default), CH-1, CH-2*

➤ The maximum power limit for regenerative discharge is equal to the maximum power limit for charge. When the input or output power of charger is limited, it will trigger the CH-1/CH-2 Channel Partiality. When **Partiality** switches to **Same**, charger assigns the output power equally to two channels, switch to CH-1 or CH-2, the charger will give priority to the selected channel output, while the output power of other channel may be reduced to 50W (discharge for 5W).

❑ Input Limit Setup

Select **SYSTEM MENU**→**Input Limit** to enter the setup interface.

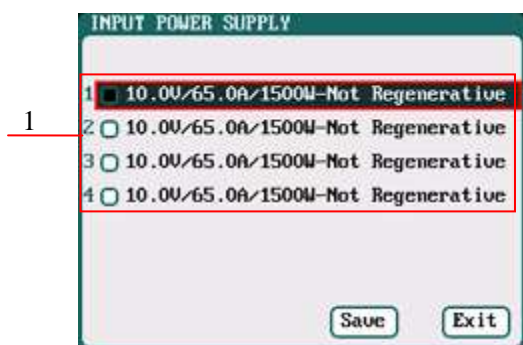

1. Four options of Input Sources

After selecting input source, enter the relevant power supply setting to set the parameters, after setting click “**Save**” to save and return to the previous interface.

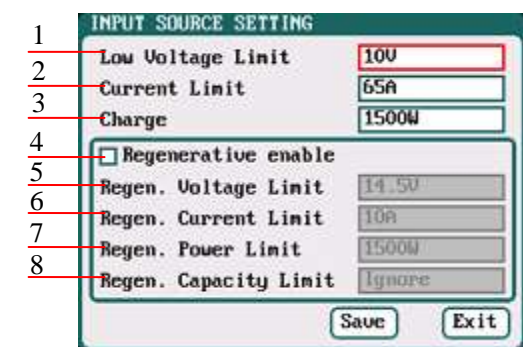

- 1.Low Voltage Limit: 9V-33V; default: 10V
- 2.Current Limit: 1A- 65A; default: 65A
- 3.Charge Power Limit: 5W-1500W; default: 1500W
- 4.Regenerative enable**
- 5.Regen. Voltage Limit: 9V-33V; default: 14.5V
- 6.Regen. Current Limit: 1A-65A; default: 10A
- 7.Regen. Power Limit: 5W-1500W; default: 1500W
- 8.Regen. Capacity Limit: *Ignore (default),100-999900mAh*

➤ After ticking **Regenerative enable**, if run the regenerative discharge to input, the electrical discharged will be re-charged as the battery of input power.

When the input source unselected, pop up the **MANAGE** interface, as below:

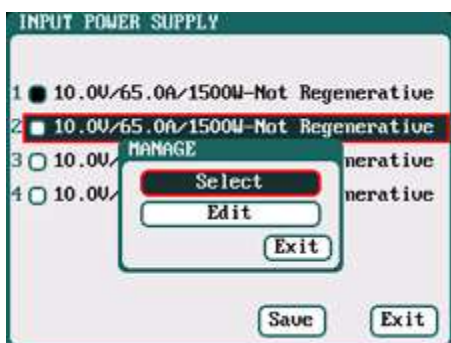

➤ The maximum possible output power of charging is restricted by the input voltage and input current: $W_{max} \approx I_{max} * V_{in} * 96\%$, The curve is as below.

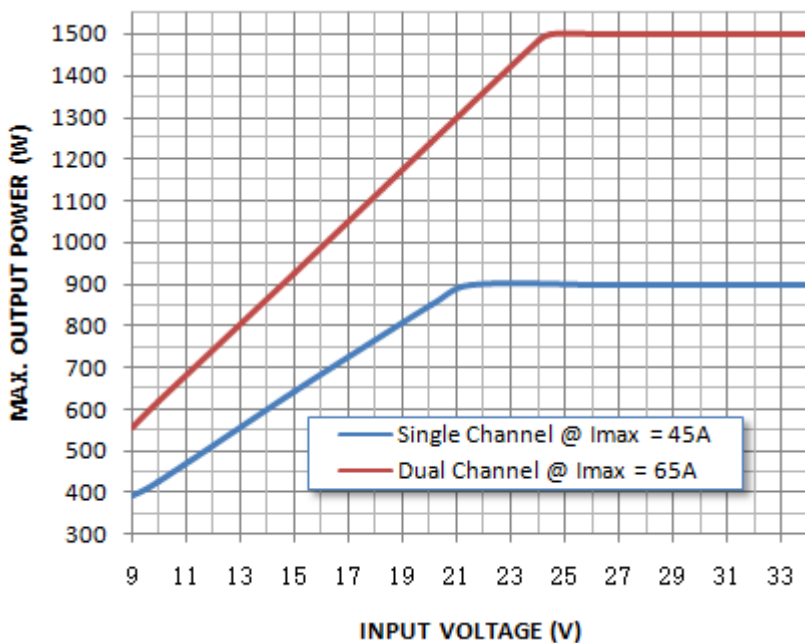

☐ Save & Load Configuration Setup

Select *Save & Load Config* on *SYSTEM MENU* and enter the setup interface.

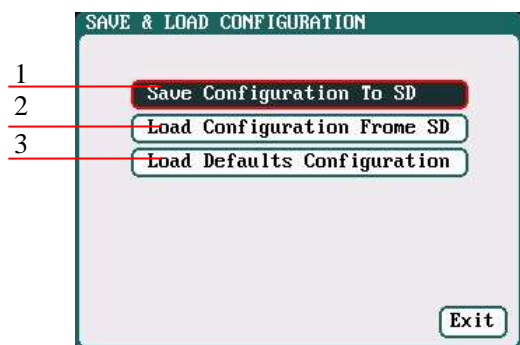

1. Save Configuration to SD card
2. Load Configuration from SD card
3. Load Defaults Configuration

➤ 1. Users can *Save Configuration To SD* card and re-load via the SD card if needed.
2. After *loading the configuration files*, in addition to *Calibration Select*, it will cover all settings within the charger.

☐ Language Setup

Select *SYSTEM MENU*→*Language* to enter the setup interface, there is English or German for the user to choose.

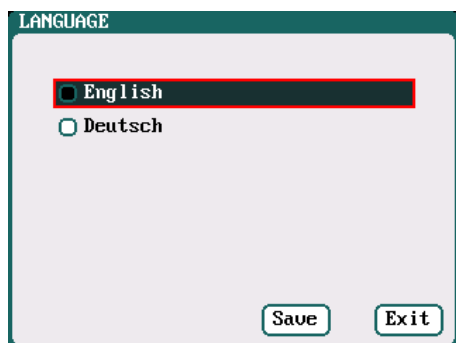

☐ Calibration

Select *SYSTEM MENU*→*Charger Setup*→*Calibration* to enter the setup interface. *User Calibration* may result in large data deviation, affecting normal use; so *User Calibration* is not suggested.

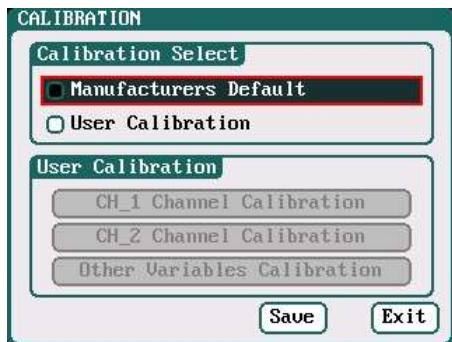

If the user select *User Calibration*, the *User Calibration* option changes to active status

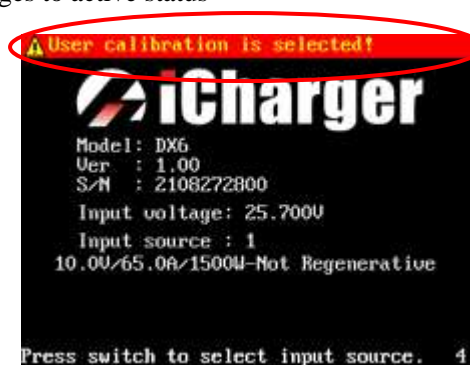
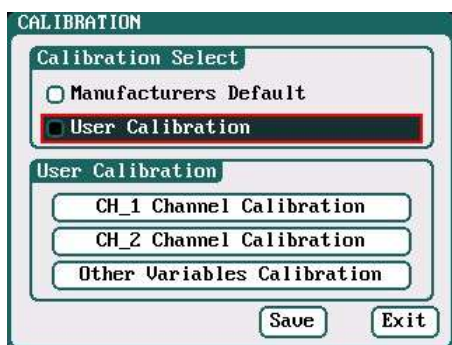

➤ If the user selects *User Calibration*, the corresponding message will appear in the interface after booting the charger, as shown in the up picture above.

Select *CH-1/2 Channel Calibration* to enter the channel calibration interface, Select *Other Variables Calibration* to enter the other variable calibration.

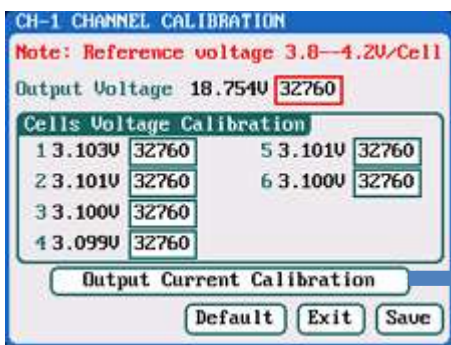

Channel Calibration

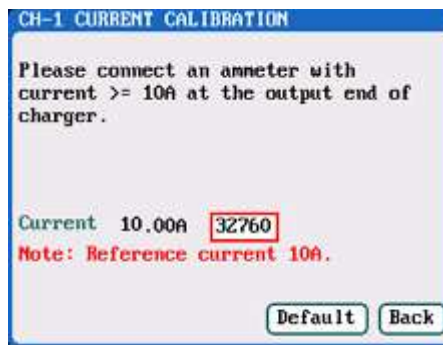

Output Current Calibration

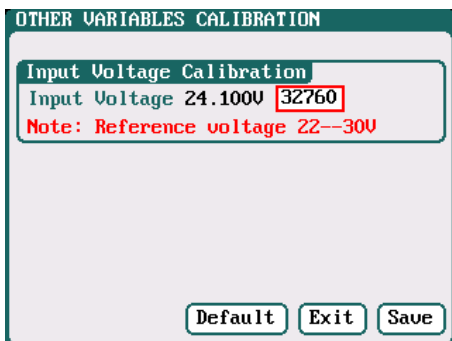

Other Variables Calibration

◆Extra Function

□Log Files Manage

Select *SYSTEM MENU*→*LOG FILES* to enter the manage interface.

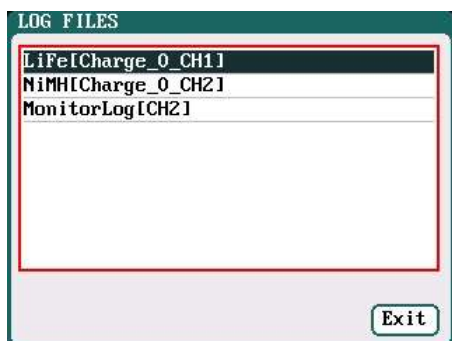

First select and click the .TXT files when managing log files and the system will pop up the *LOG FILES OP* dialog box.

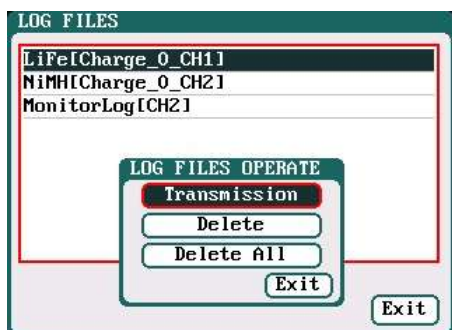

Log Files Manage Dialog

Transmission: *transmission to PC*

Delete: *delete files*

Delete All: *delete all files*

- The charger must be connected with computer via USB when select *Transmission* and the client software must have identified to the charger.

Select *Delete* to pop up the *LOG FILE DELETE* dialog box, Select *Yes* to delete this file, select *No* to cancel. And select *Delete All* to delete all.

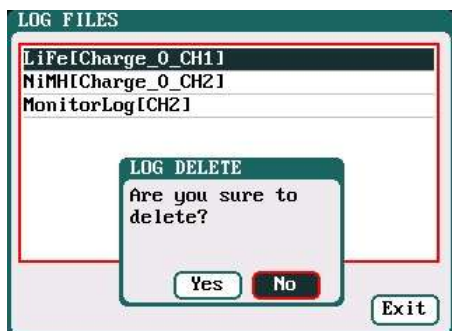

□Servo Test

Connect the servo with the multifunctional port like below, but pay attention that the port can't provide voltage for the servo, and it needs connect external power supply.

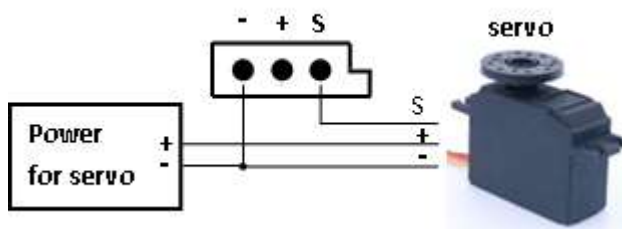

Select *SYSTEM MEN*→*SERVO TEST* to enter servo test interface; insert Servo into multi-function port to test.

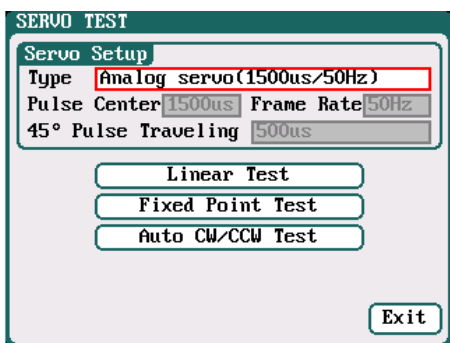

1. Type: Analog servo (1500us/50Hz)
Digital servo (1500us/333Hz)
Digital servo (760us/560Hz)
User: Pulse Center: 700us-1600us
Frame Rate: 40Hz-700Hz
45 Pulse Traveling: 100us-1000us
2. Liner test
3. Fixed point test
4. Auto CW/CCW Test

Select the test mode and go to the following corresponding interface.

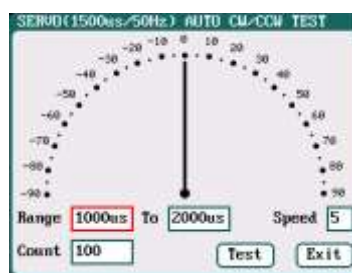
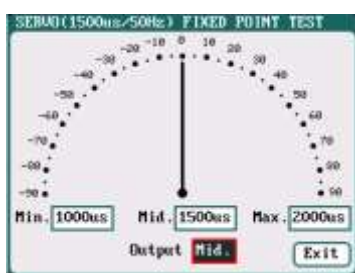
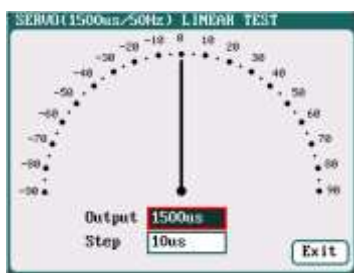

Liner Test: When turning the knob, the pointer deflects with the setting value of *Step*, and the servo responds accordingly.

Fixed Point Test: When turning knob, the pointer deflects among each setting value and the servo responds accordingly.

Auto CW/CCW Test: Click *Test* button then the pointer deflects the setting times at a set rate back and forth among each setting values, and the servo responds accordingly.

❑ Pulse Measurement

Connect the signal receiver or transistor with the multifunctional port like below, which can measure their pulse signal:

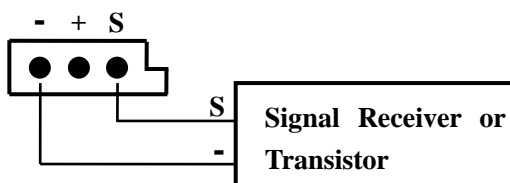

Select **SYSTEM MENU**→**Pulse Test** to enter the pulse test interface, only **CH-1 J1** port supports the input signal of Pulse Measurement.

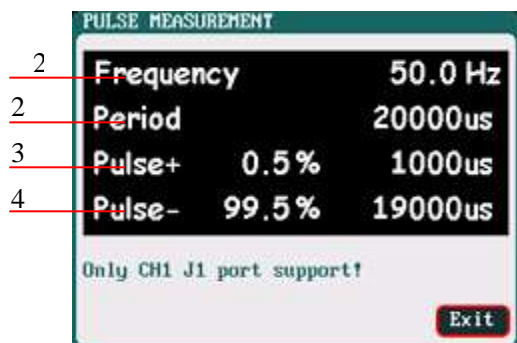

1. Pulse frequency
2. Pulse period
3. Positive pulse duty cycle and pulse width
4. Negative pulse duty cycle and pulse width

Junsi Console for DX6

Please download the software via <http://www.hillrc.com/soft/JunsiConsoleSetup.msi>, double click the file: JunsiConsoleSetup.msi to install.



1. Connect DX6 with PC via USB port (make sure USB driver has been installed), and run the software, then the system will find new equipment, so just click “Add”

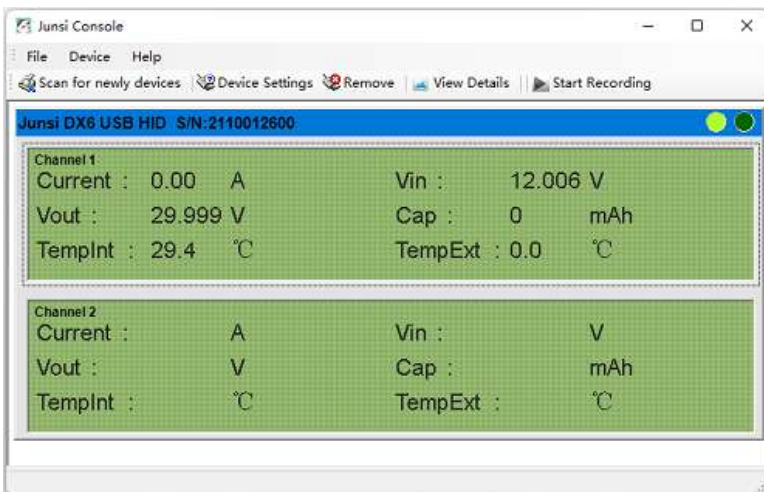

2. Click “Start recording”, and then click “View details”

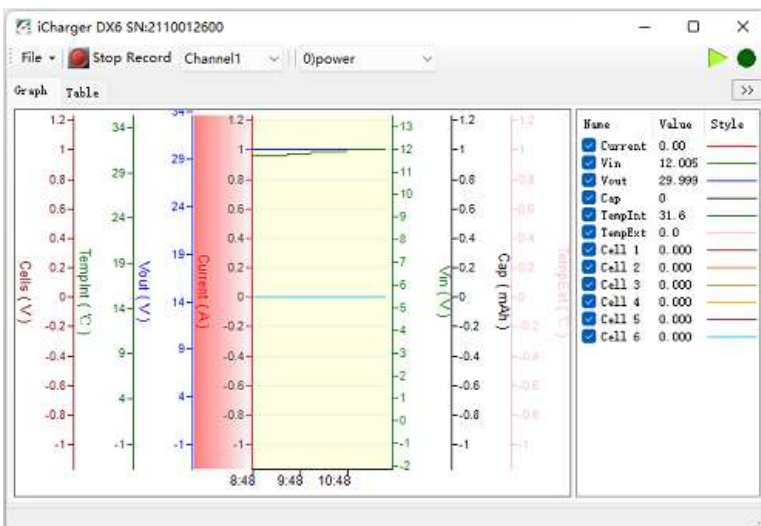

3. Start the charge/discharge program of DX6, then detailed data and curves can be viewed

Note: DX6-enabled third-party software **Data Explorer** <http://www.nongnu.org/dataexplorer/download.html>

Firmware Upgrades

●Firmware Upgrades via Junsii Console

First, connect Junsii Console for DX6 as the last chapter; then do as the follow steps to finish the update:

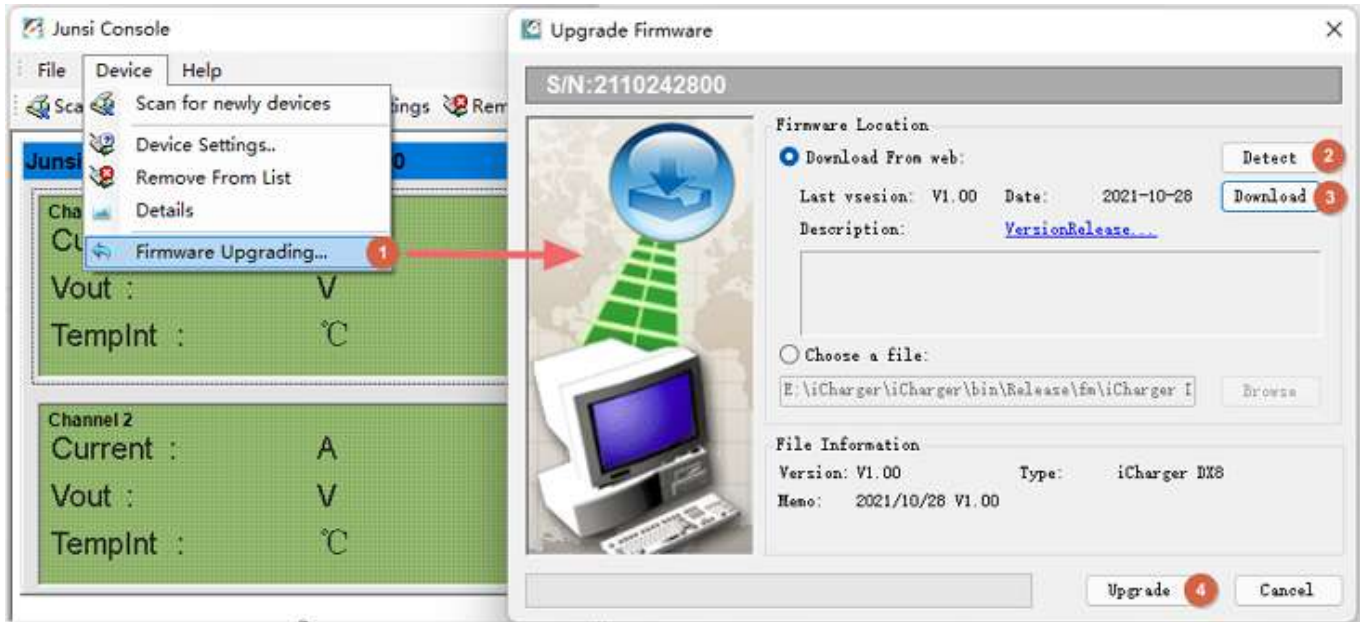

- If there is any mistake during update, please keep the power supplying for DX6 and try again.
If the charger cannot start normally for the updating (e.g.: in the event of an unexpected power outage during the update process), enter into **BOOT mode** firstly, and then update again.

●Boot Mode

Press the <●>+<STATUS-2>+<STOP/START-2> at the same time and connect the power supply of the charger, After hearing a “beep” sound, release the button.

If the charger fails to start normally (ex. Unexpected power outage), please enter the Boot mode again, it will repeat the above steps to upgrade again.

- Upgrade failed in the case of not power outages, click "  " to upgrade again;

●Firmware Upgrades via SD Card

1. Create a new directory in the available SD card: X:\Junsii\Upgrade ;
2. Rename the firmware file to **DX6.BIN**, and copied to the new directory;
3. Insert the SD card into the charge to enter **Boot mode**, the charger will automatically upgrade the firmware, and it finishes after hearing a beep sound. (The process lasts about 15 seconds, and please not turn off the power)
4. After the upgrading is complete, the charger will reboot.

Important Notes

●The Charging Principle for Reflex Charge Mode

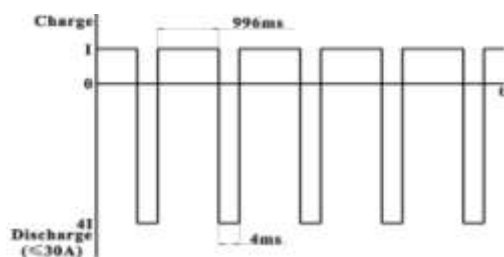

Reflex charge mode only supports NiMH and Pb battery. It does not support lithium battery. Using reflex charge mode to charge battery can reduce effectively the heating of the battery. Go to the MEMORY SETUP → Charge → Chg Mode to select Reflex mode.

●Power Regenerative Mode

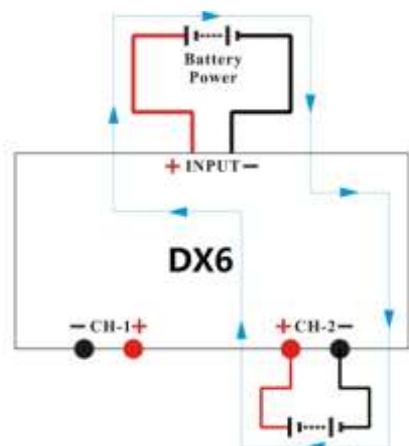

which is when the power supply for the charger acts as "battery power", the charger will regenerative charge for "battery power" during the process to discharge the battery. Go to MEMORYSETUP → Discharge → Regenerative Mode → To input.

●Channel Regenerative Mode

Channel Regenerative Mode is the feature for discharging from one channel to another channel, which supports resistor discharge, bulbs discharge, and charging battery.



- 1: Regenerative power
- 2: Regenerative voltage limit
- 3: Regenerative current limit

◆Resistance or Bulbs

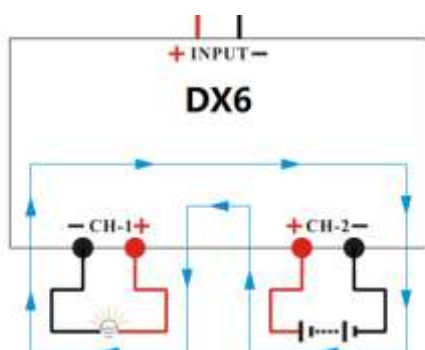

1. Connect the resistance or bulbs to any channel of the charger;
2. In another channel of the charger, MEMORY SETUP → Discharge → Regenerative Mode → To channel, to select Resistance or bulbs, then connect the battery for discharging to this channel, and start the discharge program to discharge the battery. Press STOP/START button to end the program during the period.

◆ Charging Battery

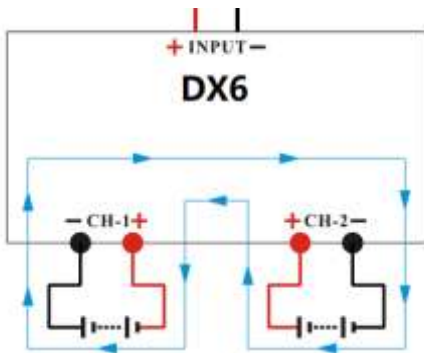

1. In any channel of the charger, *MEMORY SETUP* → *Discharge* → *Regenerative Mode* → *To channel*, to select Charging battery; then connect the battery for discharging to this channel, and start the discharge program, and this channel will be in discharging stand by status;
2. Connect the battery as the load to another channel of the charger, and start the charge program; the discharging channel is activated accordingly;
3. Press STOP/START button of any channel during the program running process to end the running status.

● Lithium Battery Extra Discharge Mode

You can expand the iCharger's discharge power capacity by connecting the external capacity resistance. You should pay special attention when expanding the discharge circuit. The balance port must be connected to the battery and the expanding capacity resistance R should be connected in series to the positive connection. (See the following diagram)

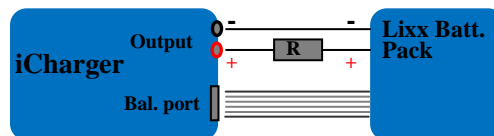

In this mode, the lithium battery discharges through the iCharger and R, $P = P_i + P_r$, (P_i is the charger's wasted power capacity; P_r is wasted power capacity by resistance). P_i is limited by the set charger's maximum discharge power capacity.

External capacity resistance's setting:

$$R = V_{bat} / I_{set};$$

$$P = V_{bat} * I_{set};$$

R: The value of the external capacity resistance

P: Rating capacity of the external capacity resistance

V_{bat}: Battery voltage

I_{set}: Discharge current

For example: discharge a pack of 20V lithium battery at 7A

$$R = 20V / 7A = 2.85\Omega$$

$$P = 20V \times 7A = 140W$$

Appendix

●Status Indication of Running Channel

Status	Status Indication	Status	Status indication
No display	No program, can select program to run	TRICK	Trickle charging status keeps a small current for a while after finishing charging NiCd or NiMH
STOPS	Stop status, press “stop” button to stop the running program	MONITOR	Monitor status, only monitors the data
START	Start the program	FLOAT	Float charge, supports Pb battery
CHECK	Check status before running program	SYNCH.	Synchronous status, this channel runs with another channel synchronously
CHARGE	Charge status	LOAD	Load status, this channel works on the load control status of Channel regenerative
DISCHG	Discharge status	WAIT	Waiting status
PRE_C	Pre-charge, program will pre-charge when the cell voltage is too low	CY_DE	Cycle delay status
KEEP	Keep charging status, keep charging for a while after setting pre-charge	OVER!	Over status
BAL	Independent balance status. Only for balancing, not charging the Li-battery,	ERROR	Error status

●Status Indication of Channel Control

Status	Status Indication	Status	Status Indication
O.CV	Constant voltage status of output	I.CC	Constant current status of input current
B.CV	Constant voltage status of battery cells	I.CP	Constant status of input power
O.CC	Constant current status of output	O.AP	Total power regulation of output
C.CP	Constant power status of output	O.BV	Channel outputs voltage are imbalance in Synchronous mode
C.TP	Temperature power reduce status	O.BC	Channel outputs current are imbalance in Synchronous mode
I.CV	Constant status of input voltage	O.PC	Channel power containment regulation status

● **Error Messages**

Error NO.	Error Messages	Error Description
02XX	"Input over voltage"	The input voltage is too high
03XX	"Input under voltage"	The input voltage is too low
04XX	"Output over voltage"	The output voltage is too high
05XX	"Low battery voltage"	The voltage of the connected battery is too low
06XX	"High battery voltage"	The voltage of the connected battery is too high
07XX	"Output over current(+)"	Output over current (+)
08XX	"Output over current(-)"	Output over current (-)
09XX	"Input over current(+)"	Input over current (+)
10XX	"Input over current(-)"	Input over current (-)
11XX	"The internal temperature is too high"	The internal temperature is too high
12XX	"The internal temperature is too low"	The internal temperature is too low
13XX	"Connection check error"	Connection check error
15XX	"Battery polarity reversed!"	Battery has been connected with polarity reversed.
16XX	"Internal control error"	Internal control checking error
17XX	"Exceed safe time limit"	Safe time limit is exceeded
18XX	"Exceed safe capacity limit"	Safe capacity limit is exceeded
19XX	"Exceed safe temperature range"	Safe temperature range is exceeded
20XX	"Output connection broken"	Output connection is broken
21XX	"Balance port connection error"	Balance port has a connection error
22XX	"Low cell voltage detected on balance port"	Low cell voltage is detected on balance port
23XX	"High cell voltage detected on balance port"	High cell voltage is detected on balance port
24XX	"Voltage match error. Balance port sum is lower than output."	Voltage matched error, the voltage of the balance port sum is lower than the output one
25XX	"Voltage match error. Balance port sum is higher than output."	Voltage matched error, the voltage of balance port sum is higher than the output one
26XX	"Number of cells doesn't match the setting"	Number of cells connected doesn't match the setting
27XX	"Number of cells setting appears low"	Number of cells setting appears low
28XX	"Number of cells setting appears high"	Number of cells setting appears high
29XX	"Balance not needed, Remove connection from balance port"	Balance port error, Ni-, Pb does not need balance port, but voltage of balance port is detected
30XX	"Balance required!"	Balance port is unplugged
31XX	"Auto detect the number of cells failed, please connect balance or set cells"	Check connection or balance port
32XX	"AD watchdog error"	AD watchdog error