

# X6 User's Manual (V1.0.4)

## Index

<b>User Notice.....</b>	<b>3 -</b>
● Safety Notes .....	3 -
● Copyright.....	3 -
● Special Features.....	4 -
● Appearance Parameters .....	4 -
● Specifications .....	4 -
<b>Device Introduction .....</b>	<b>5 -</b>
● Parts & Interface Introduction .....	5 -
● X6 Accessories .....	5 -
● Buttons Function & Icons Description.....	6 -
<b>The Connection of the Charger .....</b>	<b>7 -</b>
<b>X6 Setup &amp; Use .....</b>	<b>8 -</b>
● Power Supply Setup .....	8 -
● Program Add & Delete & Manage .....	8 -
● Run Program for Charger .....	10 -
● Program Running Status.....	11 -
● Modifying Running Program's Parameters .....	12 -
● Stop Running Program .....	12 -
● Error Messages .....	12 -
● Setup of Different Batteries.....	13 -
◆ LiPo/LiIo/LiFe/LiHV/LTO Battery Charge/Discharge Setup.....	13 -
☐ LiPo/LiIo/LiFe/LiHV/LTO Battery Charge Setup .....	14 -
➤ LiPo/LiIo/LiFe/LiHV/LTO Battery Not Balance Charge Setup .....	14 -
➤ LiPo/LiIo/LiFe/LiHV/LTO Battery Balance Charge Setup .....	14 -
➤ LiPo/LiIo/LiFe/LiHV/LTO Battery Charge Advanced Setup .....	16 -
➤ LiPo/LiIo/LiFe/LiHV/LTO Battery Charge Safety Setup .....	16 -
☐ LiPo/LiIo/LiFe/LiHV/LTO Battery Storage Setup.....	16 -
☐ LiPo/LiIo/LiFe/LiHV/LTO Battery Discharge Setup.....	17 -
➤ LiPo/LiIo/LiFe/LiHV/LTO Battery Discharge Advanced Setup.....	17 -
➤ LiPo/LiIo/LiFe/LiHV/LTO Battery Discharge Safety Setup. ....	17 -
☐ LiPo/LiIo/LiFe/LiHV/LTO Battery Cycle Setup .....	17 -
☐ LiPo/LiIo/LiFe/LiHV/LTO Battery Only Balance Feature .....	18 -
◆ NiMH/NiCd Battery Charge/Discharge Setup.....	18 -
☐ NiMH/NiCd Battery Charge Setup .....	18 -
➤ NiMH/NiCd Battery Charge Advanced Setup .....	19 -
➤ NiMH/NiCd Battery Charge Safety Setup .....	19 -
☐ NiMH/NiCd Battery Discharge Setup.....	19 -
➤ NiMH/NiCd Battery Discharge Safety Setup .....	19 -
☐ NiMH/NiCd Battery Cycle Setup .....	20 -
◆ Pb Battery Charge/Discharge Setup.....	20 -
☐ Pb Battery Charge Setup .....	20 -

➤ Pb Battery Charge Advanced Setup .....	- 20 -
➤ Pb Battery Charge Safety Setup .....	- 21 -
<input type="checkbox"/> Pb Battery Discharge Setup .....	- 21 -
<input type="checkbox"/> Pb Battery Cycle Setup .....	- 21 -
◆ NiZn Battery Charge/Discharge Setup .....	- 21 -
<input type="checkbox"/> NiZn Battery Charge Setup .....	- 21 -
➤ NiZn Battery Not Balance Charger Setup .....	- 21 -
➤ NiZn Battery Balance Charge Setup .....	- 22 -
➤ NiZn Battery Charge Advanced Setup .....	- 22 -
➤ NiZn Battery Charge Safety Setup .....	- 22 -
<input type="checkbox"/> NiZn Battery Discharge Setup .....	- 22 -
➤ NiZn Battery Discharge Advanced Setup .....	- 22 -
➤ NiZn Battery Discharge Safety Setup .....	- 22 -
<input type="checkbox"/> NiZn Battery Cycle Setup .....	- 22 -
◆ Power Setup .....	- 22 -
<b>X6 Parameters Setup .....</b>	<b>- 24 -</b>
● Parameters Setup .....	- 24 -
◆ Charger Setup .....	- 24 -
<input type="checkbox"/> Temp. & Fans Setup .....	- 24 -
<input type="checkbox"/> Beep Tone Setup .....	- 25 -
<input type="checkbox"/> LCD Setup .....	- 25 -
<input type="checkbox"/> Input & Power Limit Setup .....	- 25 -
<input type="checkbox"/> Save & Load Configuration Setup .....	- 27 -
<input type="checkbox"/> Language Setup .....	- 27 -
<input type="checkbox"/> Calibration .....	- 27 -
◆ Extra- Function .....	- 28 -
<input type="checkbox"/> Log Files Manage .....	- 28 -
<input type="checkbox"/> Servo Test .....	- 29 -
<input type="checkbox"/> Pulse Measurement .....	- 30 -
<input type="checkbox"/> Monitor Setup .....	- 30 -
● USB & SD Card Use .....	- 31 -
● Warranty & Service .....	- 31 -
<b>Junsi Console for X6 .....</b>	<b>- 32 -</b>
<b>X6 Firmware Upgrades .....</b>	<b>- 33 -</b>
● Firmware Upgrades via Junsi Console .....	- 33 -
● Firmware Upgrades via Boot Mode .....	- 33 -
● Firmware Upgrades via SD Card .....	- 33 -
<b>Important Notes .....</b>	<b>- 34 -</b>
● The Charging Principle for Reflex Charge Mode .....	- 34 -
● Power Regenerative Mode .....	- 34 -
● Lithium Battery Extra Discharge Mode .....	- 34 -
<b>Appendix .....</b>	<b>- 35 -</b>
● Status Indication of Running .....	- 35 -
● Status Indication of Control .....	- 35 -
● Error Messages .....	- 36 -

## User Notice

### ● Safety Notes

*Please read the entire Manual completely before using, to make sure you can use this device properly and more safely.*



1. Keep the charger away from children and pets at all times.
2. Never leave the charger unsupervised when charging or discharging. If you leave, disconnect the battery and switch off charger to prevent any unexpected dangers or damage.
3. Ensure the charger program and settings match the battery pack, otherwise the battery will be damaged and a dangerous situation may arise, especially for Lithium batteries, which may cause a fire.
4. Do not mix batteries of different types, different capacities or from different manufacturers.
5. Do not disassemble the charger.
6. Do not place the charger or any battery on a flammable surface or near a combustible material while in use. Do not charge or discharge on a carpet, cluttered workbench, paper, plastic, vinyl, leather or wood, inside an R/C model or inside a full-sized automobile.
7. Never block the air intake holes and never use in a refrigerated or high temperature environment. If used in such an environment, the internal temperature protection may result in abnormal charging/discharging that could be dangerous.
8. Do not allow water, moisture, metal wires or other conductive material into the charger.
9. Never charge or discharge any battery having evidence of leaking, expansion/swelling, damaged outer cover or case, color-change or distortion.
10. Do not try to charge “non-rechargeable” dry cells.
11. Do not exceed the battery manufacturer’s suggested maximum charge rates.
12. Carefully follow the battery pack manufacturer’s recommendations and safety advice.

### ● Copyright

**Copyright@ 2018 Shenzhen New Junsi Electronic Co., Ltd. All Rights Reserved.**

Without prior written consent by Shenzhen New Junsi Electronic Co., Ltd, any units or individual extracts or copies of part or the entire contents of this manual, and transmission in any form is illegal and strictly prohibited.

The product described in this manual may include copyright software ownership belonging to Shenzhen New Junsi Electronic Co. Ltd and its licensee, except with the express permission from relevant rights holders, otherwise, any copying, distribution, modification, excerpt, de-compilation, disassembly, decryption, reverse engineering, lease, transfer, sub-license, as well as other acts of infringement of software copyright is strictly prohibited, but apart from the restrictions prohibited by applicable law.

## ●Special Features

1. X6 uses advanced Synchronous buck-boost DC/DC converter technology with high power, high current and high-performance power conversion circuit. The maximum charge power capacity is up to 800W, the maximum charge/discharge current of a channel is up to 30A.
2. X6 Supports 6s LiPo, Lilo, LiFe, LiHV, LTO and NiZn batteries, with maximum 2A balance current, and adopts a unique balance calculation of internal resistance correction. Supports 1-20s NiMH/NiCd batteries and 1-12s Pb batteries.
3. With digital-power mode for great protection (over-current protection, over-voltage protection, input under-voltage protection, input undercurrent protection, and etc.)
4. Intelligent fan control. Sensing internal temperature via the internal temperature sensor, to thereby control the fan speed.
5. Internal temperature protection. When the internal temperature exceeds the Power Reduce temperature, the output power is automatically reduced; and the charger will shut down when temperature exceeds the Shut-down temperature.
6. This charger can save 32 parameters sets and support the data import/export to SD card.
7. A 2.4" IPS LCD screen provides rich information including current, voltage, power, capacity, internal resistance, control status, time-consuming and temperature, etc.
8. Multi-discharge features: self-discharge, regenerative to input discharge, and lithium battery extra expanding discharge.
9. Supports measurement for internal resistance of battery offline and online. Can measure not only the internal resistance of the entire battery pack, but also measure the internal resistance of each cell within the lithium battery.
10. X6 has protection for reversed polarity (input or output), input voltage/current, battery temperature, charging capacity, overrun time and maximum power etc.
11. Supports upgrading the hardware program by USB port or SD card. X6 also supports the “Junsu Console” software and can display, plot and analyze the charge and discharge data by it.

## ●Appearance Parameters

Display:	2.4 " IPS LCD (320×240)
Net weight:	168g
Dimension:	83×64.5×37 ±0.5mm

## ●Specifications

Input voltage range:	7—32VDC
Maximum input current limit:	<35A
Maximum charge/discharge current:	30A
Maximum charge power capacity:	800W
Maximum discharge power capacity:	30W
Maximum regenerative discharge power capacity:	800W
Maximum extra discharge power capacity:	900W @30V/30A
Maximum current drain for balancing:	>2.0A

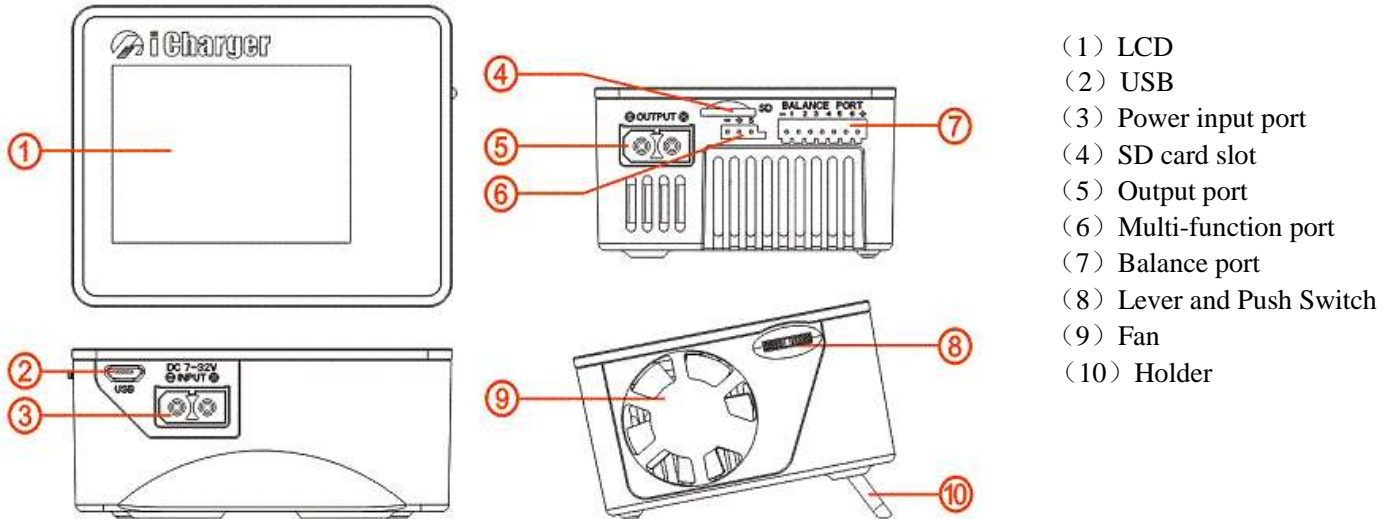

## Device Introduction

### ●Parts & Interface Introduction



➤Note: There are three features of the multi-function port: to connect temperature sensor(optional accessory) to monitor the battery temperature; to be a output port in servo test; to be an input port in pulse measurement.

### ●X6 Accessories



Standard Accessories (included in package)		Optional Accessory
<p><b>Input /Output Cable 2pcs</b></p> 	<p><b>CD ROM 1pc</b></p> 	<p><b>Temperature Sensor</b></p> 

## ●Buttons Function & Icons Description

There is only a Lever and Push Switch on the X6 charger, and we will list different symbols to indicate six conditions of the button:

Symbols	Operations	Functions & Use
<←>	Press	Enter <i>MEMORY SELECTION</i> on initial interface Confirm function or enter submenu
<←→>	Long press for 1 seconds	Enter previous running program on initial interface Pop up <i>MANAGE</i> interface on <i>MEMORY SELECTION</i> interface Delete characters when editing text Return to previous menu Stop running program
<↑>	Lever upwards	Select the up option Increase the amount
<↑→>	Lever upwards for 1 seconds	Select the up option continuously Increase the amount Measurement of internal resistance on initial interface Adjust parameters when running program
<↓>	Lever downwards	Select the down option Decrease the amount
<↓→>	Lever downwards for 1 seconds	Select the down option Decrease the amount continuously Enter <i>SYSTEM MENU</i> on initial interface Stop running program

Familiarity with the icons on the interface will help you better understand the working status of the charger, as shown in following chart:

Symbols	Functions & Use
	Fan status: a. Grey shows not running b. Green shows running (the higher the green shows, the faster the fan runs, and vice versa)
	SD card status: a. Grey shows the SD card is not inserted b. Green shows the SD card has been inserted and can be used normally
	USB status: a. Grey for no USB connection b. Green for USB connection c. Data transfer to PC, red dot flashes

## The Connection of the Charger

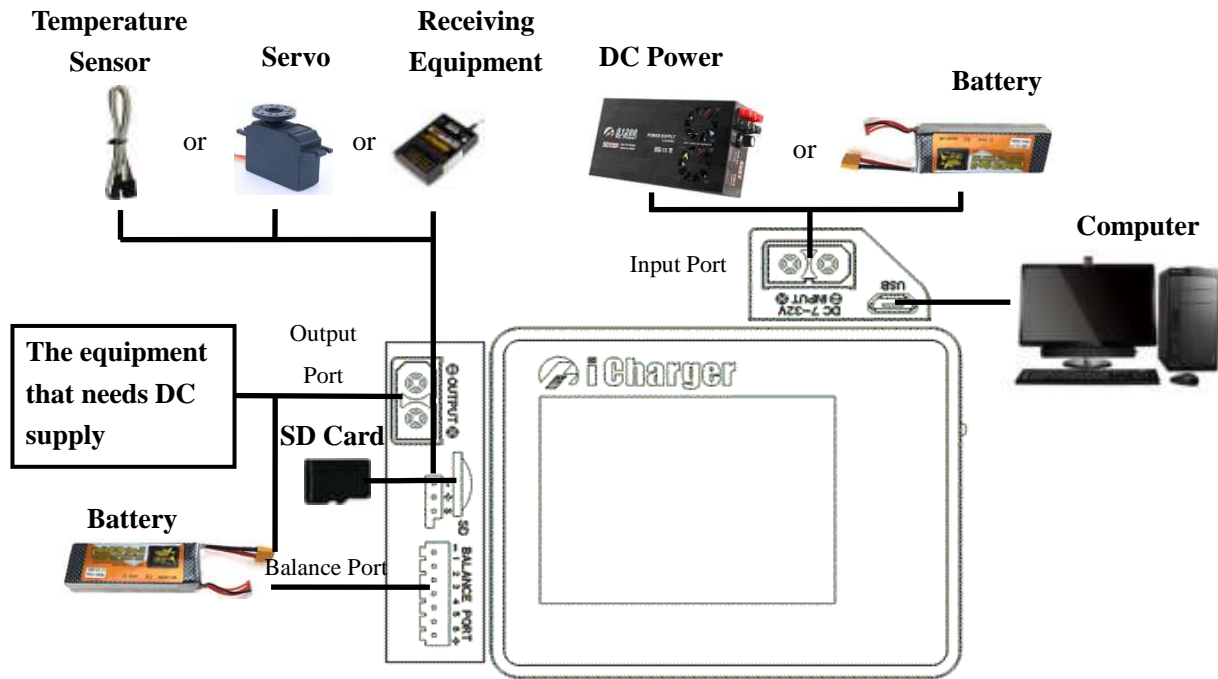

- Note: 1. Both the output port and the input port use XT60PW socket, so the user should avoid mix up, in case any damage or danger occurred.
2. The voltage of output port and the input port cannot exceed rated value (32V), and there should be no connection between, otherwise the charger will be damaged.

## X6 Setup & Use

X6 iCharger can charge/discharge *LiPo*、*Lilo*、*LiFe*、*LiHv*、*LTO*、*NiHM*、*NiCd*、*NiZn* or *Pb* batteries, this manual will explain and introduce in detail the charger's features, setup and use.

### ●Power Supply Setup

The charger boots automatically when the power is turned on and the initial interface will display LOGO, charger relevant information, power source and message etc.

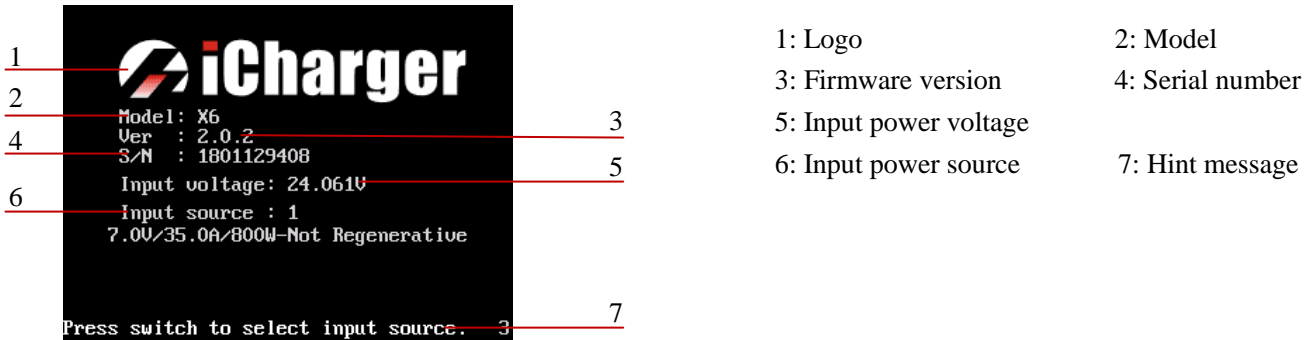

System will delay **5 seconds** after booting, during this period, press <←> to change the input source type, while pressing any other buttons to enter the initial interface.

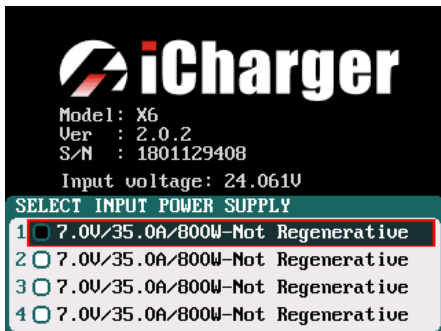

➤Note: There are different parameter setting of these four types of power supply, the user can set in *SYSTEM MENU*→ *Charger Setup*→ *Input &Power Supply*; see details on “[X6 Parameters Setup](#)”.

After selecting the input power supply, confirm and enter the initial interface.

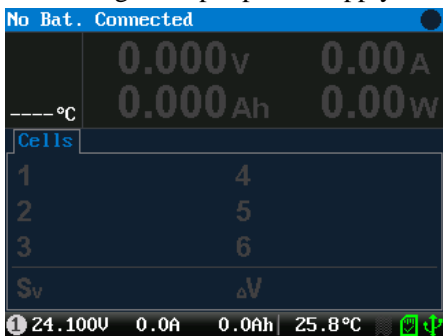

When it is not Regenerative discharging, the icon “1” on the left bottom is grey;  
When it is Regenerative discharging, the icon turns to green

### ●Program Add & Delete & Manage

Press <←> on the initial interface to pop up the *MEMORY SELECT* window, X6 has 10 default programs (shown in the following picture)



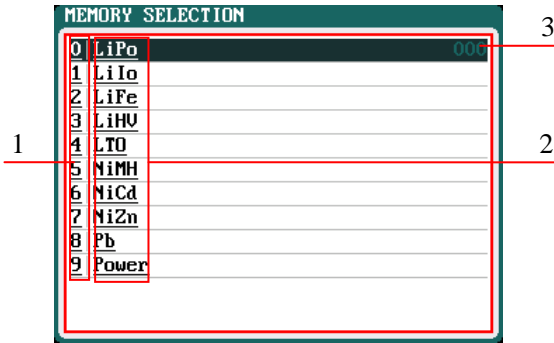

1. Program No.
2. Program Name
3. Running times

Except 10 built-in programs, there are 22 customized ones can be added. All programs include three types as below:

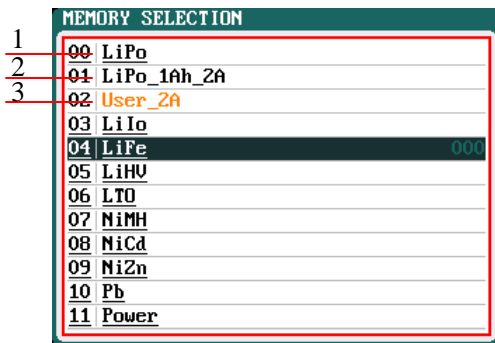

1. Built-in programs: it cannot be edited or deleted, which is in black and with underline
2. Non-User types: it can be edited or deleted, which is in black
3. User types: it can be edited or deleted, which is in orange

Press <←> to pop up *MANAGE* interface, and click "**Edit**" to enter *MEMORY SETUP* to edit the program, or click "**Add**" to add new program and enter its editing interface at the same time.

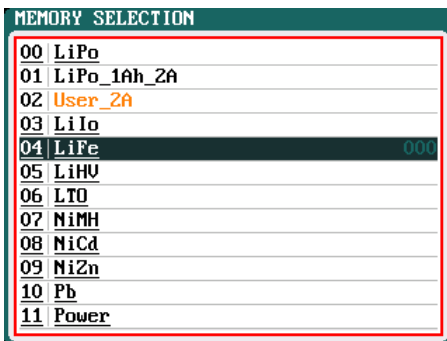

➤Note: If the program selected is a built-in program, "*Copy From...*" and "*Delete*" options are shown in grey as inactive status, and unable to be set.

After adding new programs or editing saved programs, the system will enter *MEMORY SETUP* interface. Users can set or modify the program on this interface.

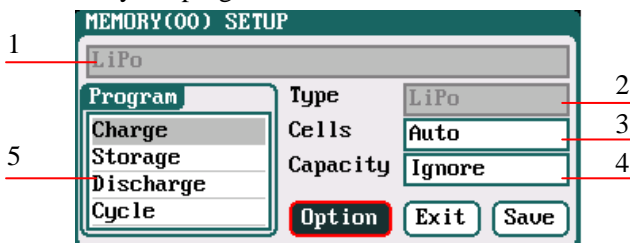

- 1: Program name
- 2: Battery type
- 3: Quantity of cells
- 4: Battery capacity
- 5: Available program

➤Note: 1. When editing the program name, to press <↑> or <↓> to select the character, <←> to confirm the selected character, <⌫> to delete the character. Press <←> after editing program name to finish. If the program name is empty, the system will name it automatically.  
2. If the Editing program is the built-in program, the program name and battery type etc. parameters cannot be changed.

After setting the basic parameters of a battery, click "Option" to enter MEMORY OPTION interface, after setting click "Back" to return to MEMORY SETUP.

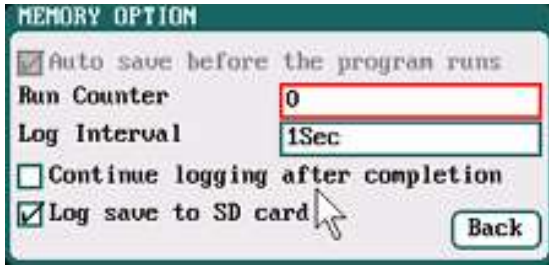

Auto save before the program runs: if ticking, the modified parameters will be saved automatically; default: ticking  
 Run Counter: 0-999; default: 0  
 Log Interval: 0.5-60Sec; default: 1Sec  
 Log save to SD card: if ticking, the Log will be saved to SD card

Note: If tick *Auto saves before the program runs*, the parameters set on the *Run program* will be saved automatically, and the *Run Program* will display "Auto save" ( shown in the following left picture), otherwise it will display "Don't save!" (shown in the following right picture);

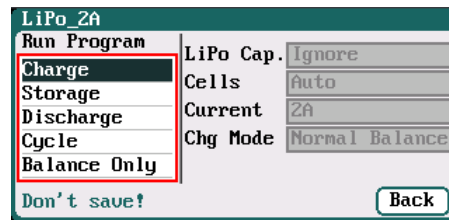
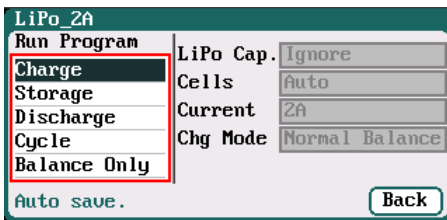

### ●Run Program for Charger

After selecting program on MEMORY SELECTION, click to enter Run Program interface (press <←> on the initial interface will enter Run Program from the last running program), as below:

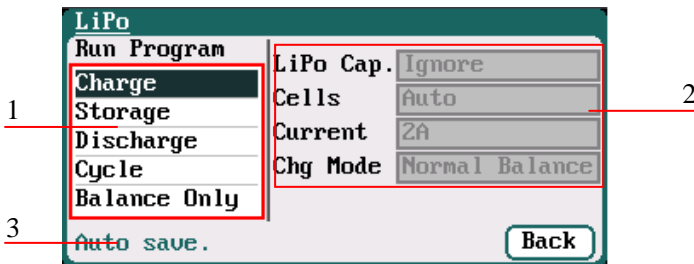

- 1: Run Program Selection
- 2: Common Parameters Setup
- 3. Auto- save Hint

Note: 1. The revised common parameters of built-in program will be saved by default automatically after running, while the program customized by the user can be set to be saved or not in MEMORY SETUP→MEMORY OPTION→Auto save before the program runs.  
 2. After setting the Cap. value, when the Current value exceeds the certain value, the system will show a warning and alarm. The Current value of each battery type is: LiXX battery :> 3C, NiMH/NiCd battery :> 2C, Pb battery :> 0.3C, NiZn battery>2C.  
 3. Press <↑> or <↓> to choose " Run Program", the common parameters are in grey, which is inalterable; if needs to change, the user can press <←>, as below:

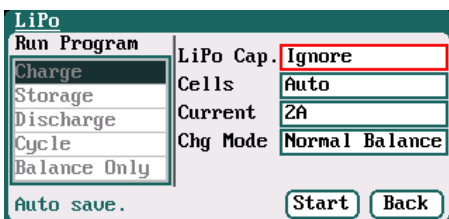

After selecting the program to run, click <←> to pop up *RUN PROGRAM* window, as below:

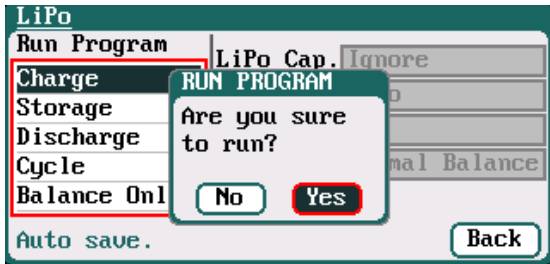

Click *Yes* to run the program, click *No* to cancel.

### ●Program Running Status

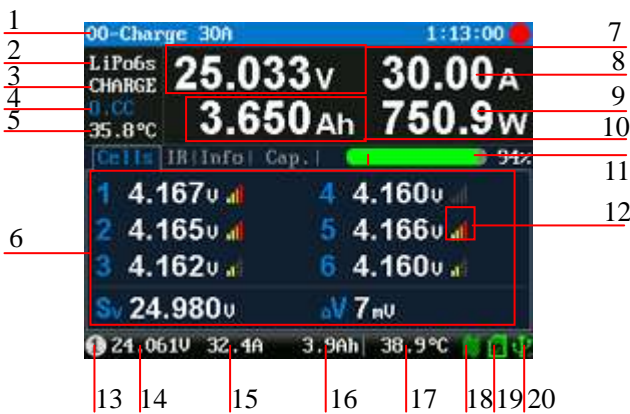

- 1: Running program name
  - 2: Battery type
  - 3: Running status
  - 4: Control status
  - 5: external temperature
  - 6: Multipage information
  - 7: Pack voltage
  - 8: Output current
  - 9: Output power
  - 10: Output capacity
  - 11: Indication of electric quantity
  - 12: Balance strength
  - 13: Input power source type
  - 14: Input voltage
  - 15: Input current
  - 16: Input capacity
  - 17: Internal temperature
  - 18: Fan status
  - 19: SD card status
  - 20: USB status
- See details on “[Status Indication of Running](#)” & “[Status Indication of Control](#)”

Press <↑> or <↓> when running program to switch the multipage information displays, as below:



- Cells voltage information
  - 1: Cells voltage
  - 2: Cells voltage sum
  - 3: Maximum cells voltage difference
- IR information
  - 1: Cells internal resistance
  - 2: Sum of all internal resistances
  - 3: Line resistance
- Information page
  - 1: Power Limit
  - 2: End voltage
  - 3: Input low volt/over current
  - 4: Safety time
  - 5: Temp. Cut-off
  - 6: End charge capacity



Capacity information

1: Cell capacity

2: Maximum cells capacity difference

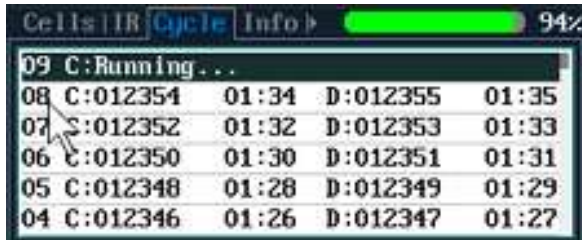

Cycle information

➤Note: Different types of batteries and programs have different multipage information displays, see details below:

Types of battery	Cells	IR	Info	Cap.	Cycle
LiPo/LiIo/LiFe/LiHV/NiZn	√	√	√	√	√
NiMH/NiCd	×	×	√	×	√
Pb	×	×	√	×	√
Power	×	×	√	×	×

### ●Modifying Running Program's Parameters

Press<↑> when running program to pop up *MODIFY* interface, to modify the current and discharge voltage parameters online, as below:

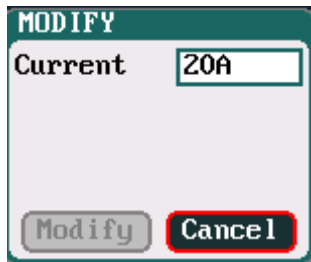

### ●Stop Running Program

Press <↓> when running program to stop running, and press<↓> again to return to the initial interface.

### ●Error Messages

During the running program, if the system detects an error, it will stop running the program on the channel immediately and pop up the red dialog box and the buzzer alarms, as below:

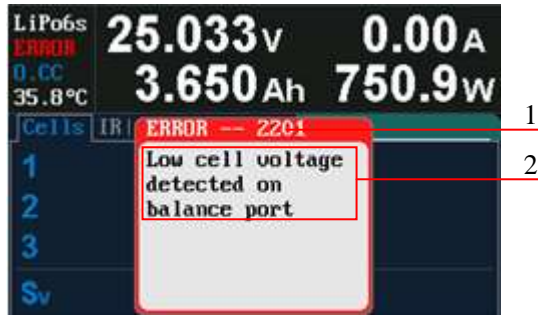

1: Error number

2: Error message

Press <↓> to exit the interface, and see all details on “Error Messages”.

## ● Setup of Different Batteries

The following form shows specific range of different batteries:

	Nominal voltage	Charge voltage	Discharge voltage	Storage voltage	Support Cells	Support Balance
<b>LiPo</b>	3.7V	3.85V—4.35V Default: 4.20V	3.00V—4.10V Default: 3.50V	3.70V—3.90V Default: 3.85V	1-6s	Yes
<b>Lilo</b>	3.6V	3.75V—4.35V Default: 4.10V	2.50V—4.00V Default: 3.50V	3.60V—3.80V Default: 3.75V	1-6s	Yes
<b>LiFe</b>	3.3V	3.30V—3.80V Default: 3.60V	2.00V—3.50V Default: 2.50V	3.10V—3.40V Default: 3.30V	1-6s	Yes
<b>LiHV</b>	3.8V	3.90V—4.40V Default: 4.35V	3.00V—4.25V Default: 3.60V	3.75V—4.10V Default: 3.90V	1-6s	Yes
<b>LTO</b>	2.4V	2.50V—3.10V Default: 2.85V	1.50V—2.90V Default: 1.80V	2.40V—2.60V Default: 2.50V	1-6s	Yes
<b>NiZn</b>	1.6V	1.20V—2.00V Default: 1.90V	0.90V—1.60V Default: 1.10V	-----	1-6s	Yes
<b>User</b>	-----	1.00V—4.80V Default: 1.00V	0.50V—4.50V Default: 1.00V	1.00V—4.50V Default: 1.00V	1-6s	Yes
<b>Pb</b>	2.0V	2.00V—2.60V Default: 2.40V	1.50V—2.40V Default: 1.80V	-----	1-12s	No
<b>NiCd/NiMh</b>	1.2V	-----	-----	-----	1-20s	No

## ◆ LiPo/LiIo/LiFe/LiHV/LTO Battery Charge/Discharge Setup

After adding a program, it will switch to LiPo/LiIo/LiFe/LiHV/LTO battery in *Type* option on the *MEMORY SETUP* interface, and set the number of *Cells* and *Capacity*, if there is no setting for the number of *Cells*, the charger will set *Auto* by default, and check *Cells* automatically via balance head. After editing all parameters for the program, click "Save" to save and return to the previous interface.

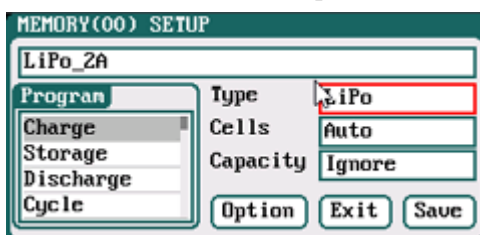

Cells: Auto (default), 1-6S

As shown in the above picture, the program of LiPo, LiIo, LiFe, LiHV and LTO battery has: *Charge, Storage, Discharge, Cycle and Balance Only*.

**LiPo/LiIo/LiFe/LiHV/LTO Battery Charge Setup**

Select *Program*→*Charge* to enter *Charge* setup interface.

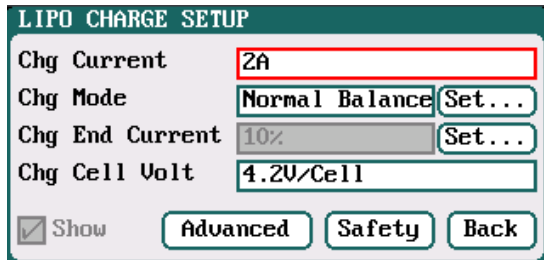

Chg Current: 0.05A-30A; default: 2A  
 Chg Mode: *Slow Balance, Normal Balance (default), Fast Balance, User Balance, Not Balance*  
 Chg End Current: 1%-50%; default: 10%  
 Chg Cell Volt: 3.85V/Cell-4.35V/Cell;  
 Default: 4.2V/Cell

- Note: 1. When the value of charge cells voltage exceeds the recommended value (LiPo 4.2V, LiIo 4.1V, LiFe 3.6V), the charger will display a warning and alarm. As long as the user changes the default value, the battery types and cells voltage value on the main charging interface will be displayed alternately.
- 2. For the setting process for all program in this manual, tick *Show* to display the setting program on *MEMORY SETUP* (shown in the following picture), and vice versa; the built-in program is ticked by default.

**LiPo/LiIo/LiFe/LiHV/LTO Battery Not Balance Charge Setup**

When switch to *Not Balance* on *Chg Mode*, Only *Chg End Current* is available for charging end condition, and "Set..." behind *Chg Mod* and *Chg End Current* are inactive.

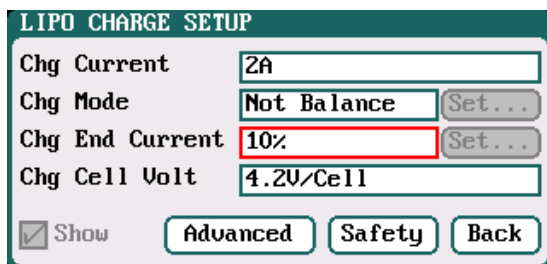

- Note: The charger first charges with constant current (CC) according to the user setting, then turns to constant voltage (CV) when the charging voltage reaches the peak point. In the CV phase the current gradually falls, and the charger will terminate charging when the current falls below the percentage of the configured charge current.

For example: the default value of Chg Current is 2A, and the default value of Chg End Current is 10%

$$\text{Chg End Current} = 2\text{A} * 10\% = 0.2\text{A}$$

Therefore it stops charging when the charging current reduces to 0.2A.

**LiPo/LiIo/LiFe/LiHV/LTO Battery Balance Charge Setup**

Switch to *Slow Balance, Normal Balance, Fast Balance or User Balance* on *Chg Mode* as the balance charge mode, and "Set..." button will be available, click it to enter *Balance* mode setup interface.

Balance Start : CV, CV-0.1V—1V, Always  
 Default: CV-0.2

If the balance charge voltage is 4.2V, Balance Start set to CV-0.2V; therefore the charger will start to balance the battery cells when the voltage reaches to 4.2V-0.2V=4V

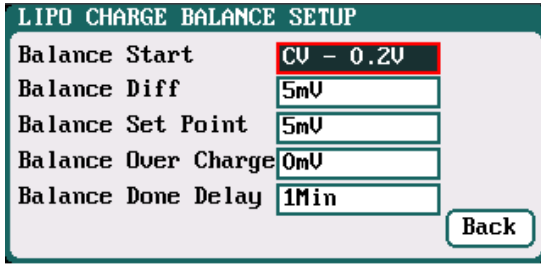

➤Note: On *Balance* mode, the charger will monitor the voltage of individual cells to control it within the Chg Cell Volt and equalize the voltage in all cells, to avoid some cell voltage over-charged or not full. When selecting *Balance* mode, the balance port of charger or balance board must be connected with battery except for connecting 1S battery.

When switch to *User Balance* mode on *Chg Mode*; the *Balance Diff*, *Balance Set Point*, *Balance Over Charge* and *Balance Done Delay* are available, after setting, click "**Back**" to return to the previous interface.

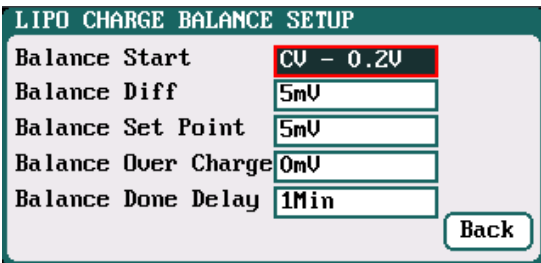

Balance Diff: 1mV-10mV; default:5mV  
 Balance Set Point: 1mV-50mV; default:5mV  
 Balance Over Charge: 0mV-50mV; default:0mV  
 Balance Done Delay: 0Min-20Min; default:1Min

➤Note: If *Balance Diff* value is lower, the voltage difference between individual cells will be lower and the balancing will take more time before the program ends. If *Balance Set Point* value is lower, the battery will be closer to the setting cut-off voltage and the time taken will be longer before the program ends. *Balance Over Charge*, the maximum overcharge compensation voltage acts as accelerated charge, and the larger the value, the more obvious the accelerated charge.

For example: Charge Lipo with  $V_{std}$ , set *Balance Over charge* to  $V_{boc}$ , the cell's internal Resistance detected is  $R_i$ , when the charge current is  $I_a$ , the actual CV value of cells is  $V_a$

$$\text{IF } R_i * I_a > V_{boc} \text{ THEN}$$

$$V_a = V_{std} + V_{boc}$$

$$\text{ELSE}$$

$$V_a = V_{std} + R_i * I_a$$

Please set this parameter after understanding fully, or keep the default value at 0.

The value of *Balance Done Delay* is larger; the battery is closer to the setting cut-off voltage when the program ends.

Switch to *Balance charge mode* on *Chg Mode*, and click "**Set...**" behind *Chg End Current* to enter *CHARGE BALANCE End SETUP* interface for setting.

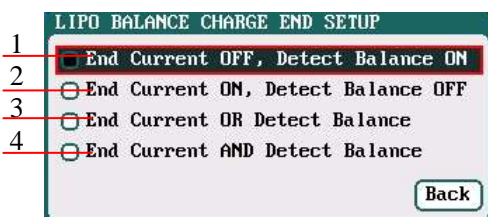

- 1: The charger will stop balance charge if detects the Balance condition is met, and the End Current condition is invalid
- 2: The charger will stop balance charge if detects the End Current condition is met, and the Balance condition is invalid
- 3: The charger will stop balance charge if detects the End Current condition or the Balance condition is met
- 4: The charger will stop balance charge if detects the End Current condition and the Balance condition are met

### LiPo/LiIo/LiFe/LiHV/LTO Battery Charge Advanced Setup

Click "**Advanced**" to enter *LiPo/LiIo/LiFe/LiHV/LTO ADVANCED SETUP*, after setting, click "**Back**" to return to the previous interface.

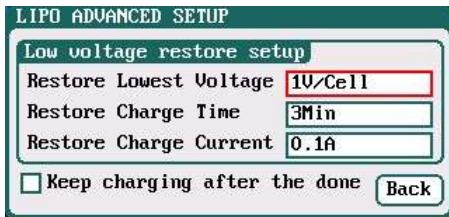

Restore Lowest Voltage:  
*0.5V/Cell-2.5V/Cell; Default: 1V/Cell*

Restore Charge Time:  
*1Min-5Min; default: 3Min*

Restore Charge Current:  
*0.02A-0.5A; default: 0.1A*

- Note: 1. When charging the over-discharged battery, the charger will detect if the cell voltage is larger than the restore voltage, if larger, it will pre-charge the battery with restore current, if within the setting restore time, the cell voltage rises to the normal value then it will turn to the charging program; otherwise it will stop running.
- 2. After charging, the battery may not be completely charged; tick *Keep charging after the done* to charge the battery with smaller current when charging ends.

### LiPo/LiIo/LiFe/LiHV/LTO Battery Charge Safety Setup

Click "**Safety**" to enter *CHARGE SAFETY SETUP*, after setting click "**Back**" to return to the previous interface.

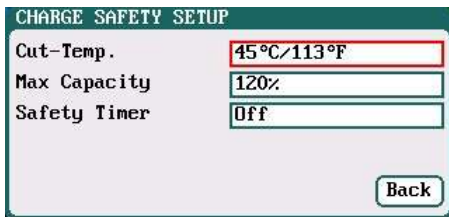

Cut-Temp: *20°C-80°C; default: 45°C*

Max Capacity: *50%-200%; default: 120%*

Safety Timer: *1Min-9999Min; default: off*

- Note: *Cut-Temp.* is the maximum safety temperature of the battery. If the temperature sensor detects the set value, the program will stop running in order to protect the battery from being damaged by high temperature.

### LiPo/LiIo/LiFe/LiHV/LTO Battery Storage Setup

This mode is for storing LiPo/LiIo/LiFe/LiHV/LTO battery that will not to be used for a long time. The charger determines whether to charge or discharge the battery based on the configured target voltage. If the battery voltage exceeds the target storage voltage, it will start to discharge, while lower than the target storage voltage, it will start to charge.

Select *Program*→*Storage* to enter *Storage* setup interface.

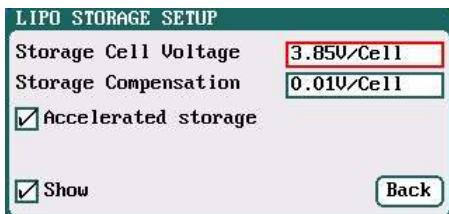

Storage Cell Voltage: *3.7V/Cell-3.9V/Cell;*  
*Default: 3.85V/Cell*

Storage Compensation: *0V/Cell-0.2V/Cell;*  
*Default: 0.01V/Cell*

- Note: 1. *Accelerated storage*: accelerate storage via internal resistance correction. Tick *Accelerated storage* to activate accelerated storage.
- 2. *Storage Compensation* is the compensation for the battery voltage fallback: for storage charge, the actual storage voltage=Storage Cell Voltage + Storage Compensation; for storage discharge, the actual storage voltage=Storage Cell Voltage - Storage Compensation.



**LiPo/LiIo/LiFe/LiHV/LTO Battery Discharge Setup**

Select *Program*→*Discharge* to enter *Discharge* setup interface.

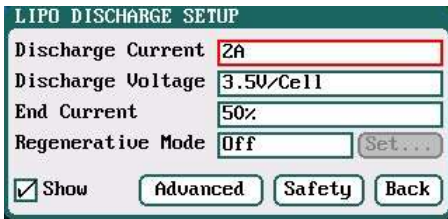

Discharge Current: 0.05A-30A; default: 2A  
 Discharge Voltage: 3V/Cell-4.1V/Cell;  
 Default: 3.5V/Cell  
 End Current: 1%-100%; default: 50%  
 Regenerative Mode: OFF (default), To input

- Note: 1. The charger first discharges with constant current (CC) according to the user setting, then turns to constant voltage (CV) when it reaches the discharge voltage. In the CV phase the current gradually falls, and the charger will terminate discharging when the current falls below the percentage of the configured discharge current.
- 2. Regenerative mode has two available settings: *Off*, *To input*, see more details on [“Important Notes”](#).

**LiPo/LiIo/LiFe/LiHV/LTO Battery Discharge Advanced Setup**

Click "**Advanced**" to enter *LiPo/LiIo/LiFe/LiHV/LTO DISCHARGE ADVANCED SETUP* interface, after setting click "**Back**" to return to the previous interface.



- Note: 1. Tick *Extra Discharge Enable* to activate *discharge enable*, see more details on [“Lithium Battery Extra Discharge Mode”](#).
- 2. Tick *Balance Enable* to activate *balance discharge*; when discharge enters the CV phase, it starts to balance the cell voltages.

**LiPo/LiIo/LiFe/LiHV/LTO Battery Discharge Safety Setup.**

Click "**Safety**" to enter *DISCHARGE SAFETY SETUP*, after setting click "**Back**" to return to the previous interface.

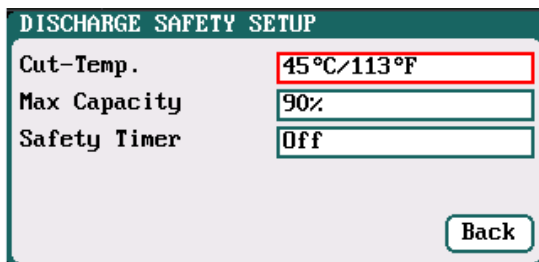

Cut-Temp: 20°C-80°C; default: 45°C  
 Max Capacity: 50%-200%; default: 90%  
 Safety Timer: 1Min-9999Min; default: off

**LiPo/LiIo/LiFe/LiHV/LTO Battery Cycle Setup**

Select *Program*→*Cycle* to enter *Cycle* setup interface, after setting click "**Back**" to return to the previous interface.

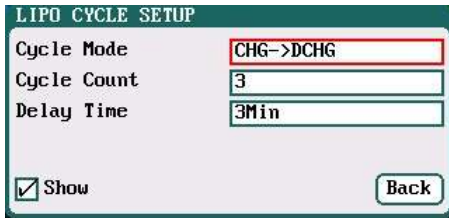

Cycle Mode:

CHG → DCHG (default), DCHG → CHG,  
 CHG → DCHG CHG, DCHG → CHG DCHG,  
 CHG → DCHG STO, DCHG → CHG STO

Cycle Count:

1-99; default: 3

Delay Time:

0Min-9999Min; default: 3Min

**□ LiPo/LiIo/LiFe/LiHV/LTO Battery Only Balance Feature**

Select *Program* → *Balance Only* to enter *Balance Only* setup interface, after setting click "Back" to return to the previous interface.



➤ Note: *Balance Only* is the program only to equalize the individual cells through balance port to reduce the voltage difference.

**◆ NiMH/NiCd Battery Charge/Discharge Setup**

After adding a program, it will switch to NiMH/NiCd battery in *Type* option on the *MEMORY SETUP* interface. Set the *Capacity*, the number of *Cells* for NiMH/NiCd battery cannot be set, and the charger sets *Auto* by default, after editing all parameters for the program, click "Save" to save and return to the previous interface.

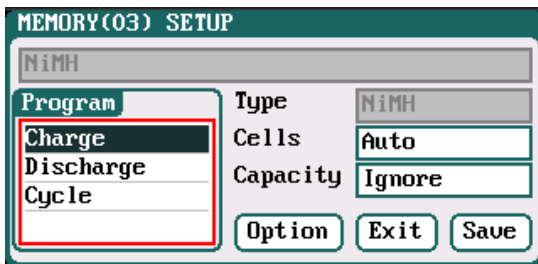

As shown in above picture, the program of NiMH, NiCd has the following modes: *Charge*, *Discharge* and *Cycle*.

**□ NiMH/NiCd Battery Charge Setup**

Select *Program* → *Charge* to enter *Charge* setup interface.

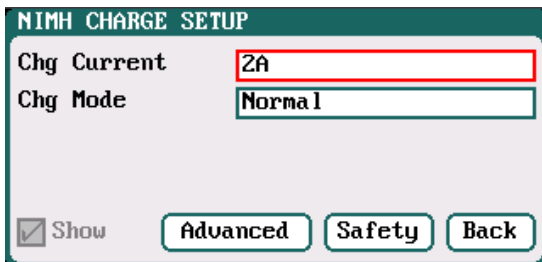

Chg Current: 0.05A-30A; default: 2A

Chg Mode: Normal (default), Reflex

➤ Note: Charge Mode has *Normal* and *Reflex* modes available; use reflex mode to charge the battery, it can reduce the heat in the battery; please see charging principle on "Important Notes".

### ☛ NiMH/NiCd Battery Charge Advanced Setup

Click "**Advanced**" to enter *NiMH/NiCd CHARGE OPTION SETUP* interface, after setting click "**Back**" to return to the previous interface.

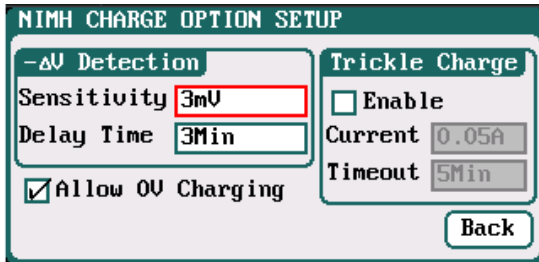

Sensitivity: 1mV-20mV; default: 3mV(NiMH), 5mV(NiCd)

Delay time: 0Min-20Min; default: 3Min

➤Note: For the over-discharged NiMH/NiCd battery, the voltage may be close to 0V, tick *Allow 0V Charging* to allow charge with 0V.

Tick *Trickle Enable*→*Enable* to activate trickle charge and set the parameters, after setting click "**Back**" to return to the previous interface.



Trickle current: 0.02A-1A; default: 0.05A

Trickle timeout: 1Min-999Min; default: 5Min

➤Note: Tick *Enable* to activate trickle charge.

Trickle charge means when the standard charge is completed, the charger will charge the battery with the setting trickle current until the setting trickle timeout, then to stop the charging process.

### ☛ NiMH/NiCd Battery Charge Safety Setup

Click "**Safety**" to enter *CHARGE SAFETY SETU* interface, see details about setting on "LiPo/LiIo/LiFe Battery Charge Safety Setup".

### ☐ NiMH/NiCd Battery Discharge Setup

Select *Program*→*Discharge* to enter *Discharge* setup interface.

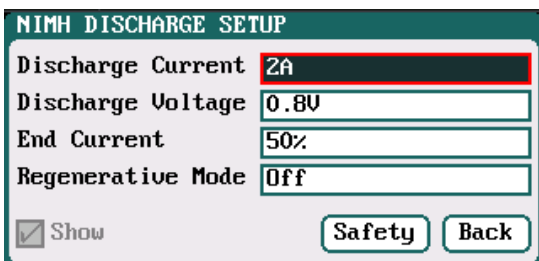

Discharge Current: 0.05A-30A; default: 2A

Discharge Voltage: 0.1V-25V; default: 0.8V

End Current: 1%-100%; default: 50%

Regenerative Mode: OFF (default), To input

➤Note: Regenerative mode has two modes available: *OFF*, *To input*. See more details on "Important Notes".

### ☛ NiMH/NiCd Battery Discharge Safety Setup

Click "**Safety**" to enter *DISCHARGE SAFETY SETUP* interface, see details about setting on "LiPo/LiIo/LiFe Battery Discharge Safety Setup".

❑ NiMH/NiCd Battery Cycle Setup

Select *Program*→*Cycle* to enter *Cycle* setup interface, see details about setting on “LiPo/LiIo/LiFe Battery Cycle Setup”.

◆ Pb Battery Charge/Discharge Setup

After adding program, it will switch to Pb battery in *Type* option on the *MEMORY SETUP* interface. Set the number of *Cells* and *Capacity*, after editing all parameters for program, click "**Save**" to save and return to the previous interface.

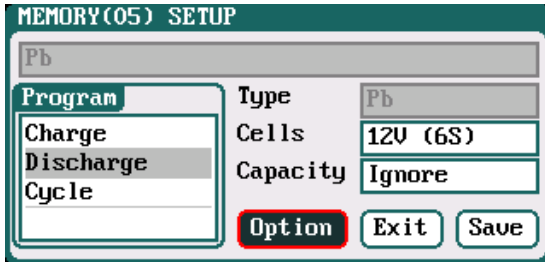

Cells: 2-24S; default: 6S

As shown in above picture, the program of Pb battery has the following modes: *Charge*, *Discharge* and *Cycle*.

❑ Pb Battery Charge Setup

Select *Program*→*Charge* to enter *Charge* setup interface.

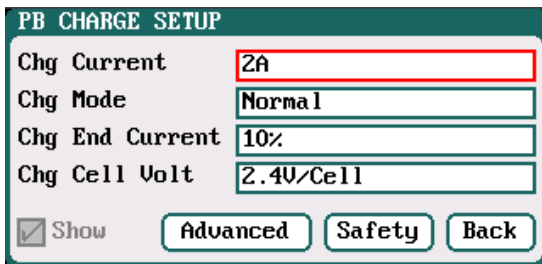

Chg Current: 0.05A-30A; default: 2A

Chg Mode: Normal (default), Reflex

Chg End Current: 1%-50%; default: 10%

Chg Cell Volt: 2V/Cell-2.6V/Cell; Default: 2.4V/Cell

- Note: 1. The charger first charges with constant current (CC) according to the user setting then turns to constant voltage (CV) when the charging voltage reaches the peak point. In the CV phase the current gradually falls, and the charger will terminate charging when the current falls below the percentage of the configured charge current.
- 2. Charge mode has *Normal*, *Reflex* two modes available, about the *Reflex* mode (Reflex) please see “Important Notes”.

☞ Pb Battery Charge Advanced Setup

Click "**Advanced**" to enter *PB ADVANCED SETUP* interface,

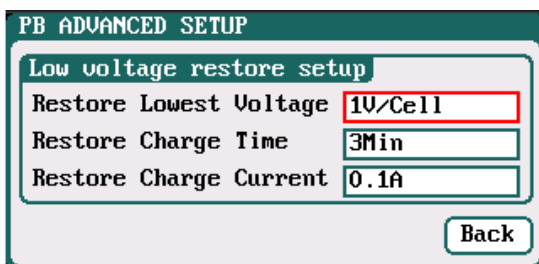

Restore Lowest Voltage: 0.5V/Cell-2.5V/Cell; default: 1V/Cell

Restore Charge Time: 1Min-5Min; default: 3Min

Restore Charge Current: 0.02A-0.5A; default: 0.1A

- Note: When charging the over-discharged battery, the charger will detect if the cell voltage is larger than the restore voltage, if larger, it will pre-charge the battery with restore current, if within the setting restore time, the cell

voltage rises to the normal value then it will turn to the charging program; otherwise it will stop running.

**☞ Pb Battery Charge Safety Setup**

Click "**Safety**" to enter *CHARGE SAFETY SETUP* interface, see details about setting on "LiPo/LiIo/LiFe Battery Charge Safety Setup".

**☐ Pb Battery Discharge Setup**

Select *Program*→*Discharge* to enter *Discharge* setup interface, see details about setting on "LiPo/LiIo/LiFe Battery Discharge Setup".

**☐ Pb Battery Cycle Setup**

Select *Program*→*Cycle* to enter *Cycle* setup interface, see details about setting on "LiPo/LiIo/LiFe Battery Cycle Setup".

**◆ NiZn Battery Charge/Discharge Setup**

After adding a program, it will switch to NiZn battery in *Type* option on the *MEMORY SETUP* interface. Set the *Capacity*, the quantity of *Cells* for NiZn battery cannot be set, and the charger sets *Auto* by default, after editing all parameters for the program, click "**Save**" to save and return to the previous interface.

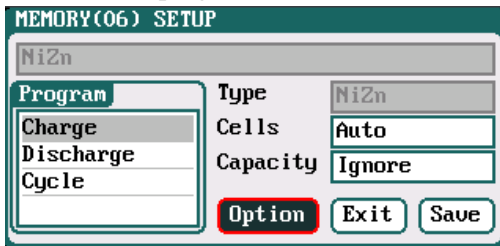

Cells: 1-6S; default: Auto

As shown in above picture, the program of NiZn has the following modes: *Charge*, *Discharge* and *Cycle*.

**☐ NiZn Battery Charge Setup**

Select *Program*→*Charge* to enter *Charge* setup interface.

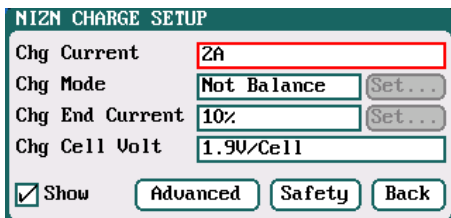

Chg Current: 0.05A-30A; default: 1.5A

Chg Mode: *Slow Balance*, *Fast Balance*, *Normal Balance*, *User Balance*, *Not Balance* (default)

Chg End Current: 1%-50%; default: 10%

Chg Cell Volt: 1.2V/Cell-2V/Cell; default: 1.9V/Cell

➤ **Note:** When the battery cell charging voltage setting exceeds the recommended value (1.9V), the charger will display a warning and alarm. As long as the user changes the value, the battery type and cell voltage values on the main interface of charger will display alternately.

**☞ NiZn Battery Not Balance Charger Setup**

Switch to *Not Balance* mode on *Chg Mode* interface, see details about setting on "LiPo/LiIo/LiFe Battery Not Balance".

Charge Setup”.

### ➤ NiZn Battery Balance Charge Setup

Switch to *Slow Balance*, *Normal Balance*, *Fast Balance*, *User Balance* on *Chg Mode* interface, see details about setting on “[LiPo/LiIo/LiFe Battery Balance Charge Setup](#)”.

### ➤ NiZn Battery Charge Advanced Setup

Click “**Advanced**” to enter *NIZN ADVANCED SETUP* interface, see details about setting on “[LiPo/LiIo/LiFe Battery Charge Advanced Setup](#)”.

### ➤ NiZn Battery Charge Safety Setup

Click “**Safety**” to enter *CHARGE SAFETY SETUP* interface, see details about setting on “[LiPo/LiIo/LiFe Battery Charge Safety Setup](#)”.

### ☐ NiZn Battery Discharge Setup

Select *Program*→*Discharge* to enter *Discharge* setup interface

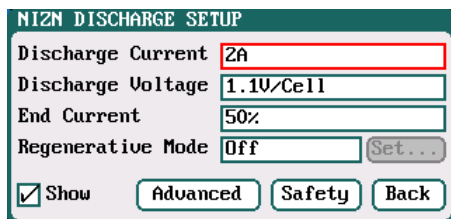

Discharge Current: 0.05A-30A; default: 1.5A

Discharge Voltage: 0.9V/Cell-1.6V/Cell; default: 1.1V/Cell

End Current: 1%-100%; default: 50%

Regenerative Mode: OFF (default), To input

➤ **Note:** 1. The charger first discharges with constant current (CC) according to the user setting then turns to constant voltage (CV) when it reaches the discharge voltage. In the CV phase the current gradually falls, and the charger will terminate discharging when the current falls below the percentage of the configured discharge current.

2. Regenerative mode has two available settings: *OFF*, *To input*, see more details on “[Important Notes](#)”.

### ➤ NiZn Battery Discharge Advanced Setup

Click “**Advanced**” to enter *NiZn DISCHARGE ADVANCED SETUP* interface, see details about setting on “[LiPo/LiIo/LiFe Battery Discharge Advanced Setup](#)”.

### ➤ NiZn Battery Discharge Safety Setup

Click “**Safety**” to enter *DISCHARGE SAFETY SETUP* interface, see details about setting on “[LiPo/LiIo/LiFe Battery Discharge Safety Setup](#)”.

### ☐ NiZn Battery Cycle Setup

Select *Program*→*Cycle* to enter *Cycle* setup interface, see details about setting on “[LiPo/LiIo/LiFe Battery Cycle Setup](#)”.

## ◆ Power Setup

X6 can be an adjustable and stabilized digital power supply, setting as below:

After adding program, it will switch to Power in *Type* option on the *MEMORY SETUP* interface. After editing all parameters for program, click "**Save**" to save and return to the previous interface.

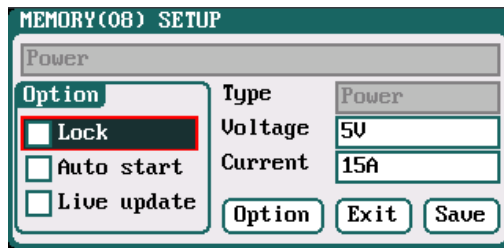

*Lock: The parameters can't be modified when running program*

*Auto start: If run this program when power off, then the program will run automatically when power on again*

*Live update: The modified parameters will take effect when running program*

*Voltage: 2V-26.5V; default: 5V*

*Current: 1A-30A; default: 15A*

## X6 Parameters Setup

### ●Parameters Setup

Press <↓> on the initial interface to enter the SYSTEM MENU interface, setting and testing of the system parameters, storage and servo can be completed on this interface.

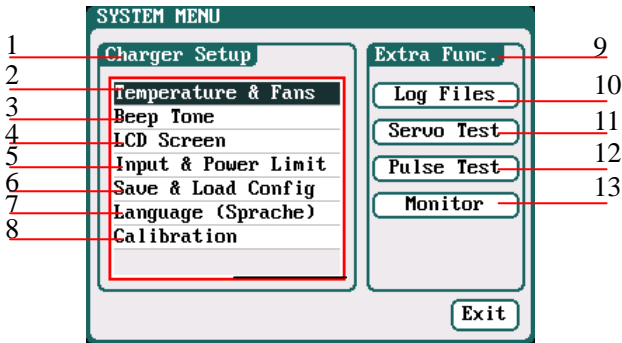

#### 1: Charger Setup Menu

- |                                    |                        |
|------------------------------------|------------------------|
| 2: Temp. & Fans Setup              | 3: Beep Tone Setup     |
| 4: LCD Setup                       | 5: Input & Power Limit |
| 6: Save & Load Configuration Setup |                        |
| 7: Language (Sprache) Setup        | 8: Calibration         |

#### 9: Extra- Function

- |                      |                |
|----------------------|----------------|
| 10: Log Files Manage | 11: Servo Test |
| 12: Pulse Test       | 13: Monitor    |

### ◆Charger Setup

After setting all parameters, click “**Save**” to save and return to the previous interface.

#### □Temp. & Fans Setup

Select *SYSTEM MENU*→*Charger Setup*→*Temperature & Fans* to enter the setup interface, after setting click “**Save**” to save and return to the previous interface.

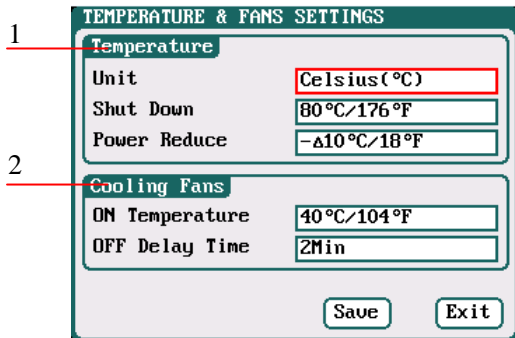

#### 1:Temperature

Unit: *Celsius (default), Fahrenheit*  
 Shut Down: *65°C-80°C; default:80°C*  
 Power Reduce: *-5°C-20°C; default:-10°C*

#### 2:Cooling Fans

ON Temperature: *30°C-50°C; default:40°C*  
 OFF Delay Time: *0Min-10Min; default: 2Min*

➤Note: When the charger’s internal temperature reaches the *ON Temperature*, the fan will start automatically to dissipate heat, and adjust speed automatically depends on the temperature increasing or decreasing. When the temperature exceeds the *Power Reduce* temperature, the charger will stop increasing (temp. shown in orange) by reducing the highest power limit. When the temperature reaches *Shut Down* temperature, the charger will shut down. [When temp. >*Shut Down*-3, the temperature is shown flashing in red]. When the temperature is lower to the *ON Temperature*, the fan will keep running within the setting time of *OFF Delay Time*.



**Beep Tone Setup**

Select *SYSTEM MENU*→*Charger Setup*→*Beep Tone* to enter the setup interface.

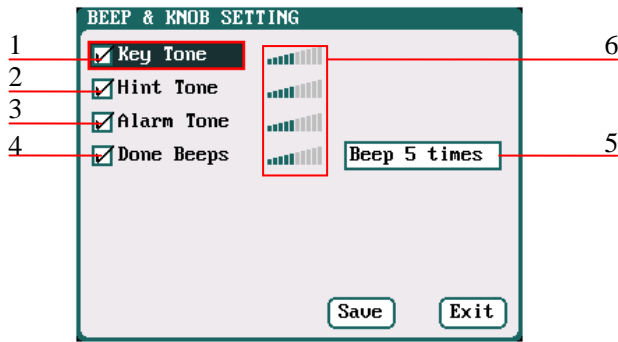

- 1: Key Tone
- 2: Hint Tone
- 3: Alarm Tone
- 4: Done Beeps
- 5: Volume adjustment display  
Beep 5times (default)  
Beep 30second  
Beep 3minutes  
Beep always
- 6: Program Done Beep Tones Selection

►Note: Tick the appropriate tone, and then go to Volume adjustment bar to adjust the volume;  
If the beep tone is not ticked the corresponding volume adjustment shows inactive; *Done Beeps* have many styles available, in sequence number 5 above.

**LCD Setup**

Select *SYSTEM MENU*→*Charger Setup*→*LCD Screen* to enter the setup interface.

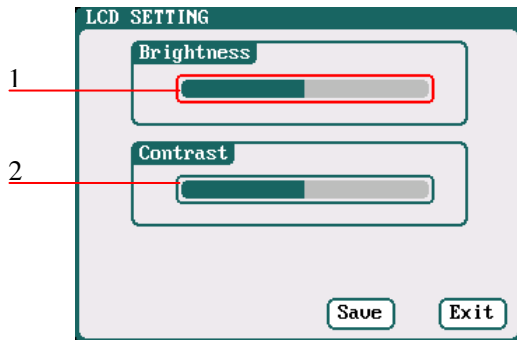

- 1: Brightness adjustment
- 2: Contrast adjustment

**Input & Power Limit Setup**

Select *SYSTEM MENU*→ *Charger Setup*→ *Input & Power Limit* to enter the setup interface.

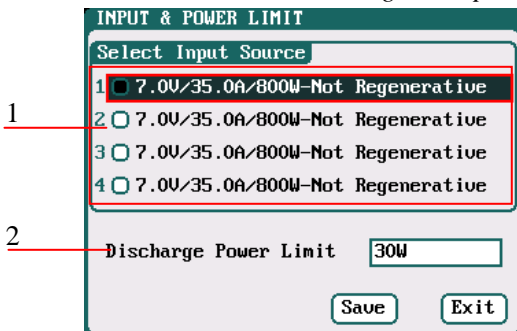

- 1: Four options of Input Source
- 2: Discharge Power Limit

After selecting input source, enter the relevant power supply setting to set the parameters, after setting click “**Save**” to save and return to the previous interface.

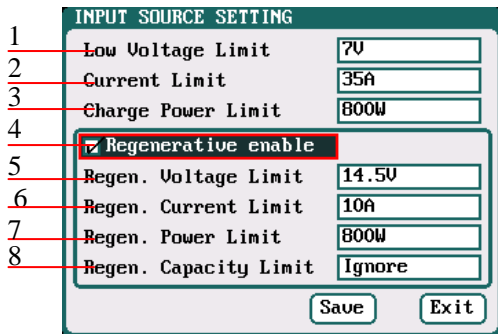

- 1: Low Voltage Limit: 7V-31V; default: 7V
- 2: Current Limit: 1A-35A; default: 35A
- 3: Charge Power Limit: 5W-800W; default: 800W
- 4: Regenerative enable**
- 5: Regen. Voltage Limit: 7V-31V; default: 14.5V
- 6: Regen. Current Limit: 1A-35A; default: 10A
- 7: Regen. Power Limit: 5W-800W; default: 800W
- 8: Regen. Capacity Limit: Ignore (default)

100mAh-999900mAh

After ticking Regenerative enable, if run the regenerative discharge to input, the electrical discharged will be re-charged as the battery of input power.

When the input source unselected, pop up the “MANAGE” window, as below:

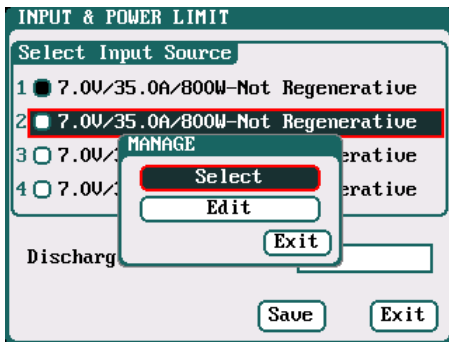

➤Note: the maximum charge output power is limited by both input voltage and input current:  $W_{max} \approx I_{max} * V_{in} * 96\%$ , when  $I_{max}$  is 35A, the curve graph is as below:



### ❑ Save & Load Configuration Setup

Select **Save & Load Config** on *SYSTEM MENU* and enter the setup interface.

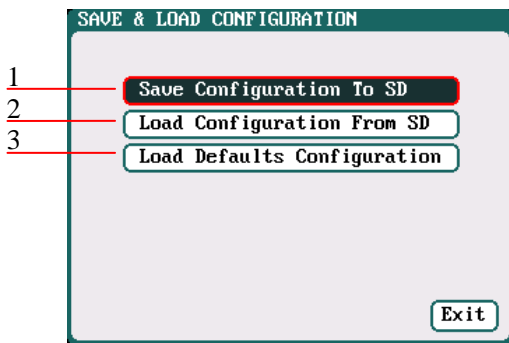

- 1: Save Configuration to SD card
- 2: Load Configuration from SD card
- 3: Load Defaults Configuration

➤ **Note:** 1. Users can save configuration to SD card and re-load via the SD card if needed.  
2. After loading the configuration files, in addition to *Calibration Select*, it will cover all settings within the charger.

### ❑ Language Setup

Select **Language** on *SYSTEM MENU* and enter the setup interface.



- 1: English
- 2: Deutsch

### ❑ Calibration

Select *SYSTEM MENU* → *Charger Setup* → *Calibration* to enter the setup interface. *User Calibration* may result in large data deviation, affecting normal use; so *User Calibration* is not suggested.

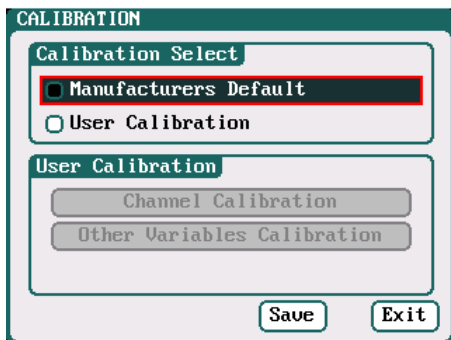

If users select *User Calibration*, the *User Calibration* option changes to active status; then select channel to enter the interface to calibrate.

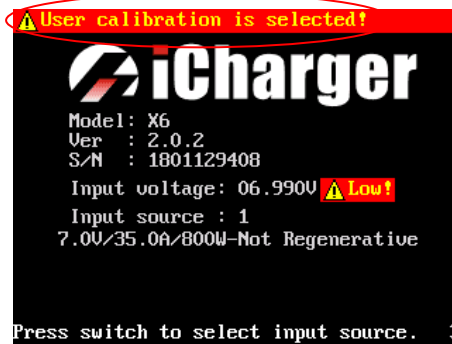
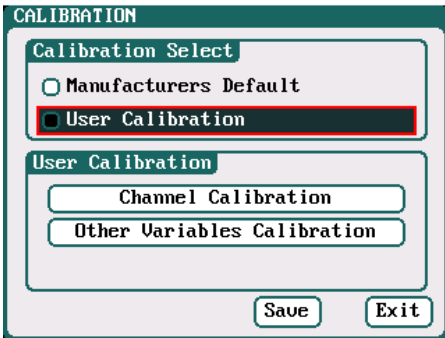

➤Note: *User Calibration* has *Channel Calibration* and *Other Variables Calibration* two options, users can calibrate charger for one channel alternatively. If user selects *User Calibration*, the corresponding message will appear in the interface after booting the charger, as shown in the right picture above.

Select *Channel Calibration* to enter the channel calibration interface, Select *Other Variables Calibration* to enter the other variable calibration; after Calibration, click "Save" to save and return to the previous interface; click "Default" to load default value.

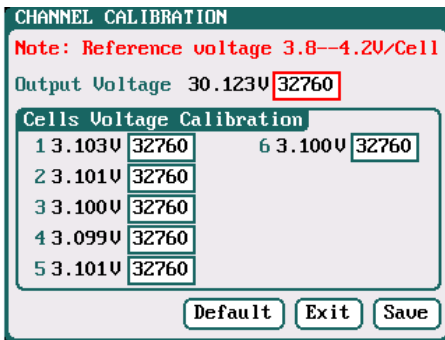

Channel Calibration

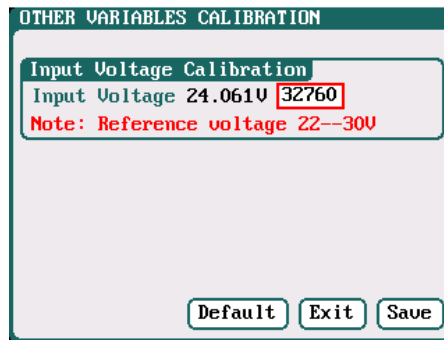

Other Variable Calibration

◆Extra- Function

☐Log Files Manage

Select *SYSTEM MENU*→*Extra Function*→*LOG FILES* to enter the manage interface.

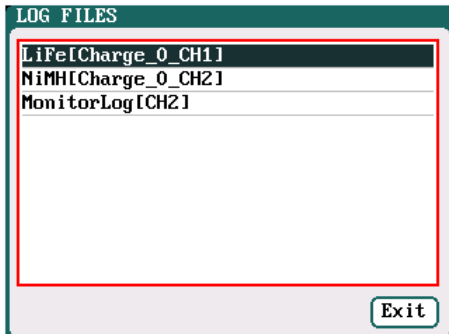

First select and click the .TXT files when managing log files, and the system will pop up the LOG FILES OP dialog box.

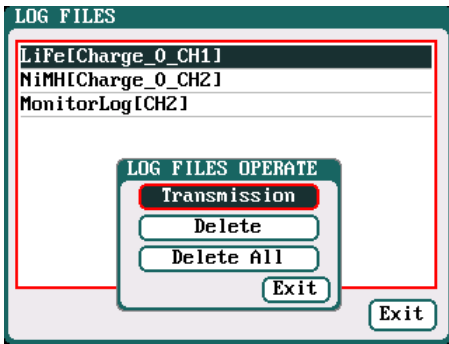

Log Files Manage Dialog

Transmission: transmission to PC

Delete: delete files

Delete All: delete all files

The charger must be connected with computer via USB when select *Transmission* and the client software must have identified to the charger.

Select *Delete* to pop up the LOG FILE DELETE dialog box, Select *Yes* to delete this file, select *No* to cancel.

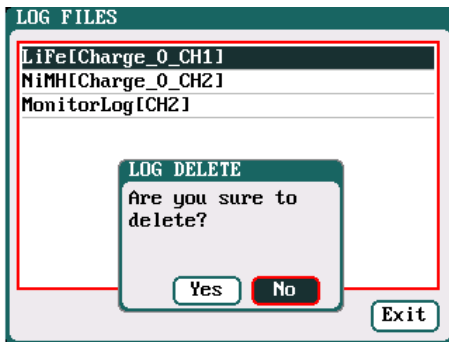

Servo Test

Connect the servo with the multifunctional port like below, but pay attention that the port can't provide voltage for the servo, and it needs connect external power supply.

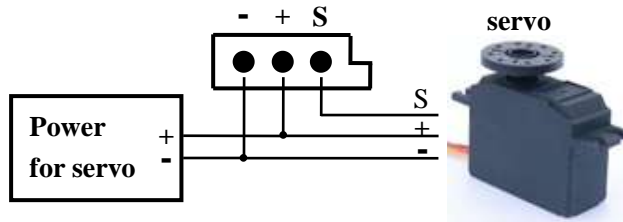

Select *SYSTEM MENU*→*Extra Function*→*SERVO TEST* to enter servo test interface; insert Servo into *J1* or *J2* port to test (only *J1* port supports Speed Test, *J2* can also be used as an external power source).

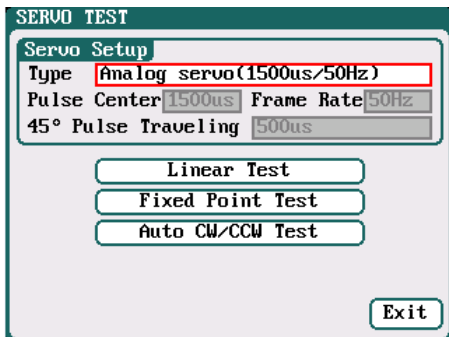

Type: *Analog servo (1500us/50Hz)*

*Digital servo (1500us/333Hz)*

*Digital servo (760us/560Hz)*

User: *Pulse Center: 700us-1600us*

*Frame Rate: 40Hz-700Hz*

*45° Pulse Traveling: 100us-1000us*

Select the test mode and go to the following corresponding interface.

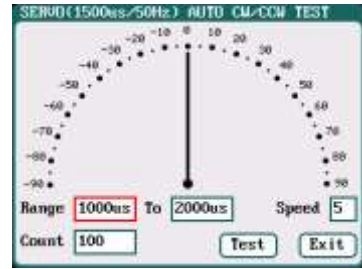
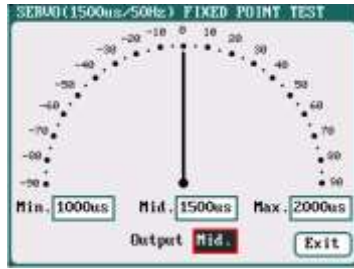
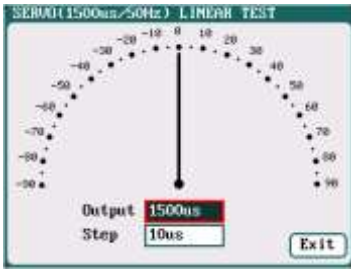

**Liner Test:** When turning the knob, the pointer deflects with the setting value of *Step*, and the servo responds accordingly.

**Fixed Point Test:** When turning knob, the pointer deflects among each setting value and the servo responds accordingly.

**Auto CW/CCW Test:** Click *Test* button then the pointer deflects the setting times at a set rate back and forth among each setting values, and the servo responds accordingly.

**❑Pulse Measurement**

Connect the signal receiver or transistor with the multifunctional port like below, which can measure their pulse signal:

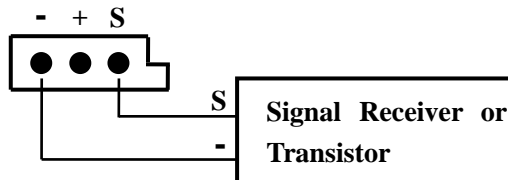

Select *SYSTEM MENU*→*Extra Function*→*Pulse Test* to enter the pulse test interface

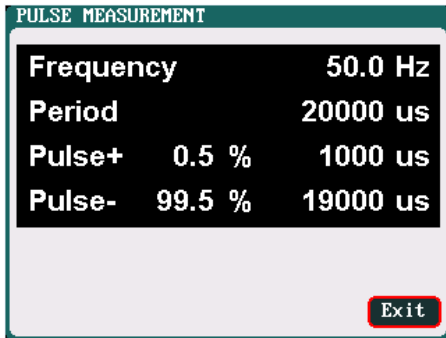

**❑Monitor Setup**

Select *SYSTEM MENU*→*Extra Function*→*Monitor Settings* to enter the manage interface.

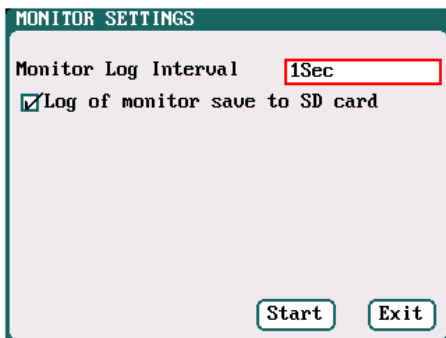

Monitor Log Interval: *1Sec*

After ticking *Log of monitor save to SD card*, the log will be saved to SD card automatically.

## ●USB & SD Card Use

X6 is the HID device of USB, supported by windows system directly, dispense with installing additional drivers. The USB icon will light up on the lower right corner of the screen when the X6 connects with computer normally. The SD icon will light up on the lower right corner of the screen when the SD card is inserted. If X6 connects with the USB without running a program, the new added U disk can be found on the "My Computer" of the PC, and can operate the file. *Log* files are stored in the *X:\Junsi\X6\Log* folder and *config.* files are stored in the *X:\Junsi\X6\System* folder.

- Note: 1. The file system of SD card must be FAT, FAT32, or *exFAT*.  
2. Data in SD card needs to be backed up in case it is lost.

## ●Warranty & Service

- ① The product from the date of purchase enjoys free repair service within one year under normal conditions of use.
- ② Over the warranty, if replacement parts are needed the appropriate charge for components and repair will apply.
- ③ During the warranty period, any of the following circumstances will not enjoy free repairs:
  - 1) Failure to use in accordance with the requirements of the user manual.
  - 2) Failure or damage caused by the unauthorized user dismantling, appending or modifying the charger.
  - 3) Failure or damage due to natural disasters, bruises, collisions and incorrect supply voltages.

## Junsi Console for X6

Please download the software via <http://www.hillrc.com/soft/JunsiConsoleSetup.msi>, double click the file: JunsiConsoleSetup.msi to install.

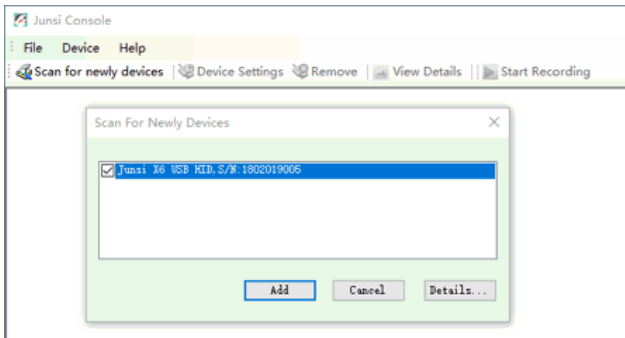

1. Connect X6 with PC via USB port (make sure USB driver has been installed), and run the software, then the system will find new equipment, so just click “Add”

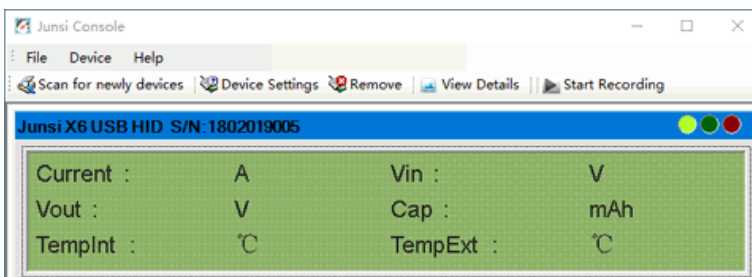

2. Click “Start recording”, and then click “View details”

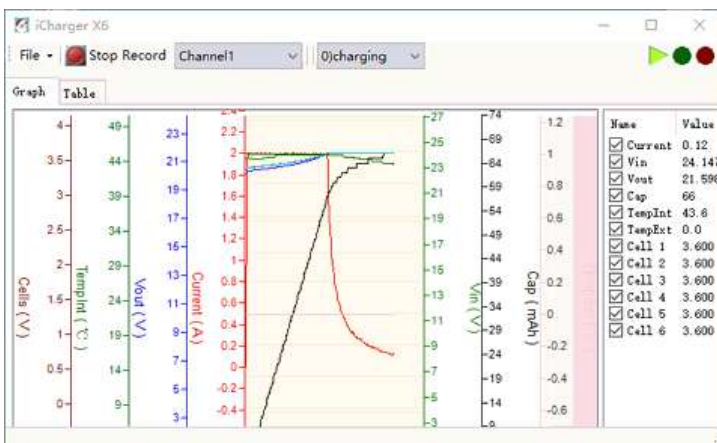

3. Start the charge/discharge program of X6, then detailed data and curves can be viewed

Note: X6-enabled third-party software **Data Explorer** <http://www.nongnu.org/dataexplorer/download.html>



## X6 Firmware Upgrades

### ● Firmware Upgrades via Jungsi Console

First, connect Jungsi Console for X6 as the last chapter; then do as the follow steps to finish the update:

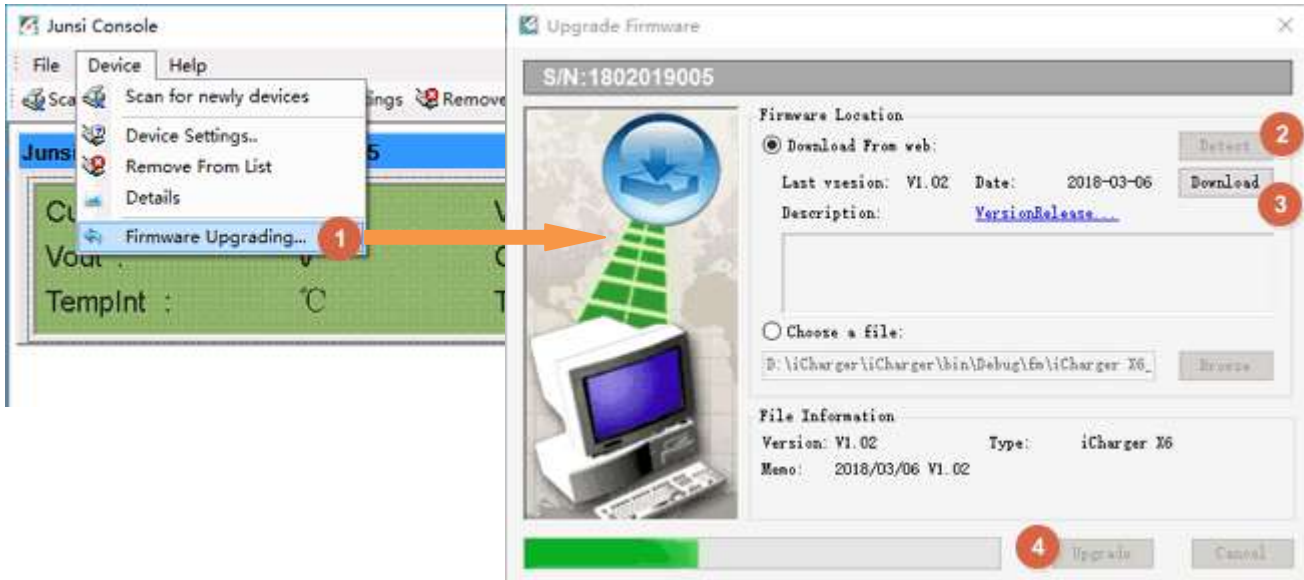

➤ **Note:** If there is any mistake during update, please keep the power supplying for X6 and try again.

If the charger cannot start normally for the updating (e.g.: in the event of an unexpected power outage during the update process), enter into BOOT mode firstly, and then update again.

### ● Firmware Upgrades via Boot Mode

Press the <←> and connect the power supply of the charger, and hold for 4 seconds. After hearing a “beep” sound, release the button.

Then press the <↕> and hold for 4 seconds, the charger will into Boot mode once there is three “beep” sound, and the button can be released now.

If the charger fails to start normally (ex. Unexpected power outage), please enter the Boot mode again, it will repeat the above steps to upgrade again.

➤ **Note:** Upgrade failed in the case of not power outages, click " Update... " to upgrade again;

### ● Firmware Upgrades via SD Card

1. Create a new directory in the available SD card: *X:\Jungsi\Upgrade* ;
2. Rename the firmware file to X6.BIN, and copied to the new directory;
3. Insert the SD card into the charge to enter Boot mode, the charger will automatically upgrade the firmware, and it finishes after hearing a beep sound. (The process lasts about 15 seconds, and please not turn off the power)
4. After the upgrading is complete, the charger will reboot.

## Important Notes

### ●The Charging Principle for Reflex Charge Mode

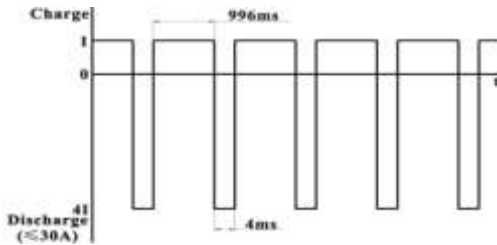

Note: Reflex charge mode only supports NiMH and Pb battery. It does not support lithium battery. Using reflex charge mode to charge battery can reduce effectively the heating of the battery. Go to the *MEMORY SETUP* → *Charge* → *Chg Mode* to select *Reflex* mode.

### ●Power Regenerative Mode

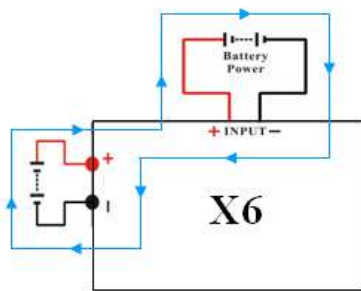

Note: Power Regenerative Mode: which is when the power supply for the charger acts as "battery power", the charger will regenerative charge for "battery power" during the process to discharge the battery. Go to *MEMORYSETUP* → *Discharge* → *Regenerative -Mode* to select *To input* mode.

### ●Lithium Battery Extra Discharge Mode

You can expand the iCharger's discharge power capacity by connecting the external capacity resistance. You should pay special attention when expanding the discharge circuit. The balance port must be connected to the battery and the expanding capacity resistance R should be connected in series to the positive connection. (See the following diagram)

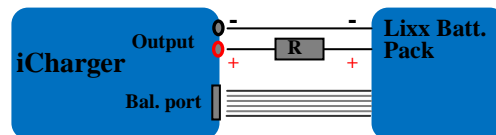

In this mode, the lithium battery discharges through the iCharger and R,  $P = P_i + P_r$ , ( $P_i$  is the charger's wasted power capacity;  $P_r$  is wasted power capacity by resistance).  $P_i$  is limited by the set charger's maximum discharge power capacity.

#### External capacity resistance's setting:

$$R = V_{bat} / I_{set};$$

$$P = V_{bat} * I_{set};$$

R: The value of the external capacity resistance

P: Rating capacity of the external capacity resistance

Iset: Discharge current

Vbat: Battery voltage

For example: discharge a pack of 20V lithium battery at 7A

$$R = 20V / 7A = 2.85\Omega$$

$$P = 20V \times 7A = 140W$$

## Appendix

### ●Status Indication of Running

Status	Status Indication	Status	Status indication
No display	No program, can select program to run	TRICK	Trickle charging status keeps a small current for a while after finishing charging NiCd or NiMH
STOPS	Stop status, press “stop” button to stop the running program	MONITO	Monitor status, only monitors the data
START	Start the program	FLOAT	Float charge, supports Pb battery
CHECK	Check status before running program	SYNCH.	Synchronous status, this channel runs with another channel synchronously
CHARGE	Charge status	LOAD	Load status, this channel works on the load control status of Channel regenerative
DISCHG	Discharge status	WAIT	Waiting status
PRE_C	Pre-charge, program will pre-charge when the cell voltage is too low	CY_DE	Cycle delay status
KEEP	Keep charging status, keep charging for a while after setting pre-charge	OVER!	Over status
BAL	Independent balance status. Only for balancing, not charging the Li-battery,	ERROR	Error status

### ●Status Indication of Control

Status	Status Indication	Status	Status Indication
O.CV	Constant voltage status of output voltage	I.CC	Constant current status of input current
B.CV	Constant voltage status of Li-battery cells voltage	I.CP	Constant status of input power
O.CC	Constant current status of output current	O.C0	0 current regulation status
C.CP	Constant status of output power capacity	O.CP	Total power regulation status
C.TP	Temperature power reduce status	C.BL	Channel imbalance regulation status
I.CV	Constant status of input voltage	O.PC	Channel power containment regulation status

● **Error Messages**

Error NO.	Error Messages	Error Description
02XX	"Input over voltage"	The input voltage is too high
03XX	"Input under voltage"	The input voltage is too low
04XX	"Output over voltage"	The output voltage is too high
05XX	"Low battery voltage"	The voltage of the connected battery is too low
06XX	"High battery voltage"	The voltage of the connected battery is too high
07XX	"Output over current(+)"	Output over current (+)
08XX	"Output over current(-)"	Output over current (-)
09XX	"Input over current(+)"	Input over current (+)
10XX	"Input over current(-)"	Input over current (-)
11XX	"The internal temperature is too high"	The internal temperature is too high
12XX	"The internal temperature is too low"	The internal temperature is too low
13XX	"Connection check error"	Connection check error
14XX	"CH1 & CH2 common-negative connection prohibited"	Common-negative connected to CH1&CH2 is prohibited
15XX	"Battery polarity reversed!"	Battery has been connected with polarity reversed.
16XX	"Internal control error"	Internal control checking error
17XX	"Exceed safe time limit"	Safe time limit is exceeded
18XX	"Exceed safe capacity limit"	Safe capacity limit is exceeded
19XX	"Exceed safe temperature range"	Safe temperature range is exceeded
20XX	"Output connection broken"	Output connection is broken
21XX	"Balance port connection error"	Balance port has a connection error
22XX	"Low cell voltage detected on balance port"	Low cell voltage is detected on balance port
23XX	"High cell voltage detected on balance port"	High cell voltage is detected on balance port
24XX	"Voltage match error. Balance port sum is lower than output."	Voltage matched error, the voltage of the balance port sum is lower than the output one
25XX	"Voltage match error. Balance port sum is higher than output."	Voltage matched error, the voltage of balance port sum is higher than the output one
26XX	"Number of cells doesn't match the setting"	Number of cells connected doesn't match the setting
27XX	"Number of cells setting appears low"	Number of cells setting appears low
28XX	"Number of cells setting appears high"	Number of cells setting appears high
29XX	"Balance not needed, Remove connection from balance port"	Balance port error, Ni-, Pb does not need balance port, but voltage of balance port is detected

30XX	"Balance required!"	Balance port is unplugged
31XX	"Auto detect the number of cells failed, please connect balance or set cells"	Check connection or balance port
32XX	"AD watchdog error"	AD watchdog error
33XX	"Synchronous mode: Channel outputs imbalance"	Channel outputs are imbalance in Synchronous mode
34XX	"This channel is needed to access the resistor or bulb load"	This regenerative channel is needed to access the resistor or bulb load
35XX	"The other channel is occupied"	The other channel is occupied