



Q6 Lite Smart Charger

Operating Instructions Ver 1.1.179

Introduction

Q6 Lite, a high-performance smart charger, is innovatively produced by ISDT.

Please visit : www.isdt.co for more details on the functions of this smart charger, as well as purchase various accessories.

Functions of products will be kept on upgrading, the manual in your hand may be different from the actual operation; please refer to the actual functions.

This manual was last updated on September 2017.



Revolution Starts Here

Innovative reform, Friendly to use

Contents

Warnings and Safety Tips	04
Product Parameters and Characteristics	05
Default Battery Type of Charger and Task Parameters	07
How to Confirm Charging Current	08
Task Setting	09
Working Parameters Display	12
System Default	14
Troubleshoot	15
Product Qualification Declaration	16

Warnings and Safety Tips

The following safety tips are essentially important. Please strictly follow the manual's instructions in operation to guarantee safety. Improper operation or incorrect working parameter settings may cause damages to the charger and battery and/or result to a fire.

- Do not use the charger in an unattended manner; in case of any functional abnormality, please stop using it and refer to the manual.
- Keep the charger away from dust, humidity, rain and high temperature, as well as avoid direct exposure to the sun and intense vibration.
- Power input of the charger is direct current 7-32V; make sure the polarities are correct when connecting to the power supply.
- Please place the charger on a heat-resisting, non-flammable and insulating surface. Do not use it by placing it on the car's seats, carpet or other similar places. Keep inflammable and explosive objects away from operation areas of the charger.
- Make sure the heat emission hole at the bottom of the charger is uncovered while in use, and ensure the cooling fan smoothly extracts heat.
- Please fully understand the charging and discharging characteristics as well as the battery's specifications. Additionally, set up proper charging parameters in the charger. Incorrect setting of parameters can cause damage to the charger and battery and/or result to disastrous consequences such as fire or explosion.
- When charging or discharging is completed, please press the speed shuttle key to terminate current task, and remove the battery when the charger shows the standby screen.

Product Parameters and Characteristics

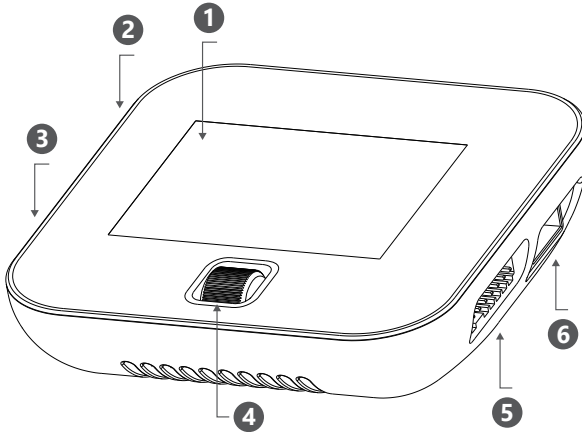

- 1. 2.4" IPS Display
- 2. Power Input
- 3. Update Port

- 4. Speed Shuttle key
- 5. Balanced Port
- 6. Battery Port

Guide For the Connection of Balanced Port

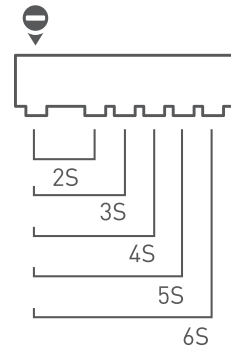

Speed Shuttle key

Long press: enter system setting / terminate current task
Short press: enter task setting / confirm current setting
Horizontal scroll: select menu

Product Parameters and Characteristics

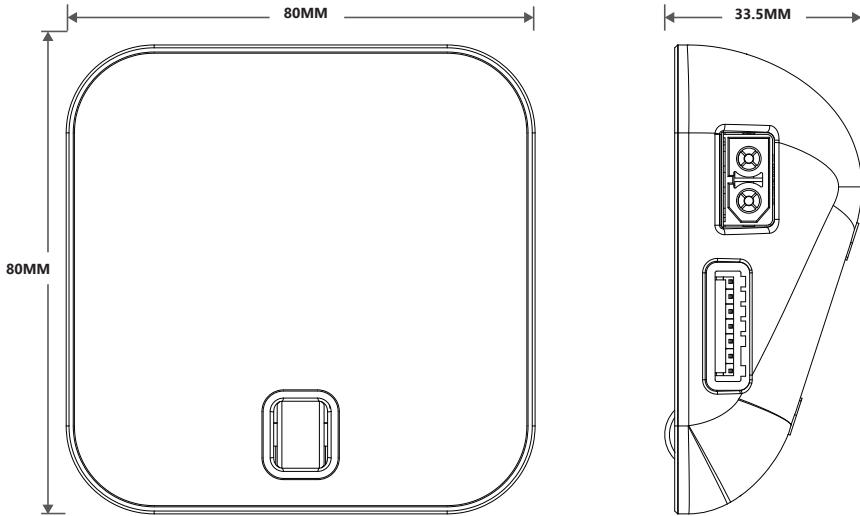

Specifications:

Input Voltage: DC 7-32V	Supported Batt. Type: LiFe/Lilon/LiPo/LiHv (1-6S)
Output Voltage: 0-30V	NiMH/Cd(1-16S)
Charge Current: 0.1-8.0A	Pb(1-12S)
Discharge Current: 0.1-3.0A	Display: 2.4" ' 320x240 IPS LCD
Max Charge Power: 200W	Operating Temperature: 0-40 °C
Max Discharge Power: 5W	Storage Temperature: -20-60 °C
Balance Current: 0.8A/cell	Dimensions: 80x80x33.5 mm
Balance Cells: 1-6S	Weight: 119g

Default Battery Type of Charger and Task Parameters

	NiCd/NiMH	Pb	LiFe	Lilon	LiPo	LiHv
Rated Voltage	1.20V	2.00V	3.20V	3.60V	3.70V	3.80V
Full Charge Voltage	1.40V	2.46V	3.65V	4.10V	4.20V	4.35V
Storage Voltage	Not supported	Not supported	3.30V	3.70V	3.80V	3.85V
Discharge Voltage	1.10V	1.90V	2.90V	3.20V	3.30V	3.40V
Pre-charge Voltage	0.90V	1.80V	2.60V	2.90V	3.00V	3.10V
Balance Charge	Not supported	Not supported	supported	supported	supported	supported
Unbalanced Charge	supported	supported	supported	supported	supported	supported
Support Cells	1-16	1-12	1-6S	1-6S	1-6S	1-6S
Max Charge Current	8.0A	8.0A	8.0A	8.0A	8.0A	8.0A

Please be cautious when selecting the charging parameters for different types of batteries; otherwise, the batteries may be damaged. Incorrect setting can result to fire and/or explosion.

How to Confirm Charging Current





It is very important to know the maximum charging current of the battery as excessive current could influence the life span of battery and/or cause damages. In addition, excessive current can cause heating and/or explosion of the battery during the charging process.

The charging and discharging capacity of battery is usually marked with C value. Multiplying the charging C value and battery capacity equals to the maximum charging current supported by the battery. For example, for a 1000 mAh battery with a charging capacity of 5C, the maximum charging current would be $1000 \times 5 = 5000\text{mA}$; therefore, the maximum charging current is 5A.

For a lithium battery, if it is impossible to confirm the supported charging C value, please set the charging current below 1C for the sake of its (lithium battery) safety.

The reference relation between C value and charging time: charging time ≥ 60 minutes/charging C value (it therefore needs around 60~70 minutes to complete charging with 1C). Due to differences in battery conversion efficiency, the period to complete the charging might be extended.

Task Setting

Task Setting	
 Task	4.18 V
 Battery type	4.19 V
<input checked="" type="checkbox"/> Cell voltage 	4.20 V
 Cells count	4.21 V
<input checked="" type="checkbox"/> Current setting	4.22 V
 Start	4.23 V

← Recommended Voltage

End-voltage setting

Connect the charger to the power supply and wait for the system to complete the self testing. Connect the battery to the charger under standby interface, and short press the shuttle key to make the task setting menu to pop up. The items in the menu are as follows:

Task	Select task contents: Charge, Discharge, Storage
Battery type	Select battery types
Cells voltage	End-voltage slight adjustment, range $\pm 0.05V$
Cells count	Select batteries' strings, and the item processes automatic test and needs no setting if inserted in balanced interface
Current setting	Select current, charge/storage 0.1 - 8 A, discharge 0.1 - 3.0 A
Start task	Start to execute tasks
Back	back

Task Setting

The working mode of the charger is series charging; you must therefore connect it to the output line of the battery while charging. For a lithium battery, it is highly suggested that the balanced interface should be connected to carry out balanced charging to accurately monitor the voltage of each cell and balance the ones with bad consistency.

● Storage functions

When selecting storage functions, automatic charging task can be initiated if the battery is lower than the preset storage voltage; likewise, automatic discharging task can be initiated if the battery voltage is higher than the preset storage voltage. To save time during charging and discharging tasks, the voltages of cells should not be accurately balanced; however, it is normal phenomenon that there may be some errors between cell voltage and preset value as the tasks are completed[Unclear (very confusing)].

● Activation and restoration functions of excessive discharged battery

Activation and restoration functions of excessive discharged battery

When the charging task begins, a 0.1 A current should be applied to activate and restore the battery if the cell voltage is tested to be lower than the pre-charge voltage; on the other hand, it should be adjusted to a rated voltage for charging when the cell voltage is higher than the pre-charge voltage. This design can protect excessively discharged batteries, as well as conduct activation and restoration.

● Internal resistance measurement function

The charger is equipped with a function of measuring the cells' internal resistance, which is only applied when conducting balanced charging. The cell voltage should be measured and calculated within 2 to 3 minutes after the charging task has been initiated. The battery internal resistance can slightly vary under different electric quantities while the measured resistance value is usually relatively low as the electric quantity is large.

The charging current should be adjusted instantly as the charger measures the internal resistance of the battery; therefore, it is normal phenomenon for acute change of current to occur during charging.

Task Setting

Since the way of internal resistance measurement varies, it cannot be realized to measure the absolute value as professional internal resistance tester does. Therefore, the internal resistance value can only be referred to when conducting horizontal comparisons, such as judging the consistency of the cells' performance or making comparisons of the performance of different cells. The charging current is an influential factor for measuring internal resistance; batteries with large capacity and small internal resistance would relatively need large charging currents to accurately measure the internal resistance.

● Judgment of complete charging

During the charging process, the screen displays an orange marking which turns into green or blue as the charging is completed. When the charging completes, the cells' voltage difference should be smaller than 20mV, while the screen marking turns into green. Therefore, if the battery is in urgent use, it's okay to stop charging. The charger should continue to balance the battery if the charging process is not terminated, and the screen light turns blue, since the voltage difference is smaller than 10mV. Additionally, the charger should continue to carry out accurate balancing of the battery after the light turns blue. If the consistency of the cells is excellent, the screen light should skip color green to become blue as the charging is complete.

After the charging is complete, it is normal for voltage decline to occur due to different performances. As the number of the charge cycle grows, the performance decreases, and the voltage decline phenomenon becomes obvious. To charge the battery with a larger current would also cause a more obvious voltage decline after the charging is complete.

NB: When charging the battery in a hurry in outdoors, it is okay to stop charging when the screen light turns green. If there is enough time and the cells are assumed to be well balanced, it is better to stop charging when the screen light turns blue; alternatively, wait a little longer after that to gain more accurate balance effects.

Working Parameters Display

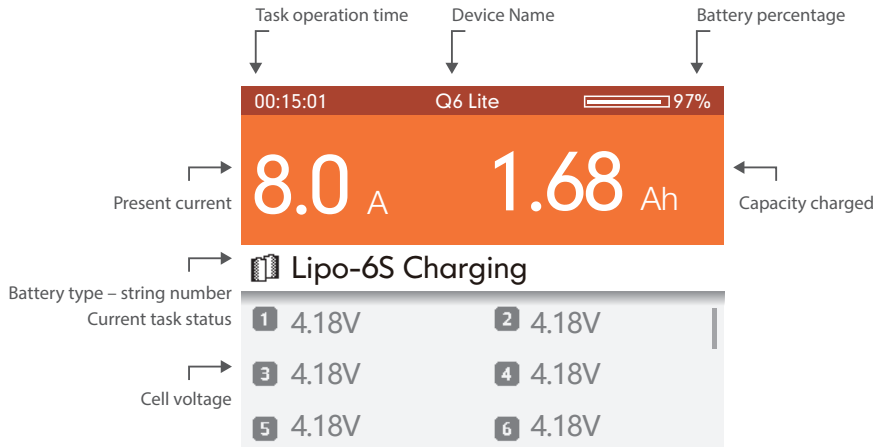

Fast Charging

Rotating the shuttle key during operation can switch the displayed information in the lower half of the screen, which are cell voltage, cell internal resistance and working parameter. The cell voltage and internal resistance can only be displayed in the mode of balance charging (3 minutes).

Working Parameters Display

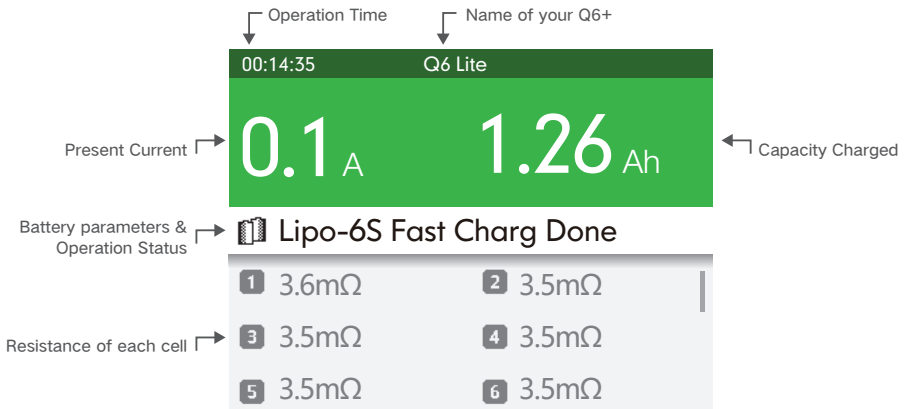

Fast charging complete

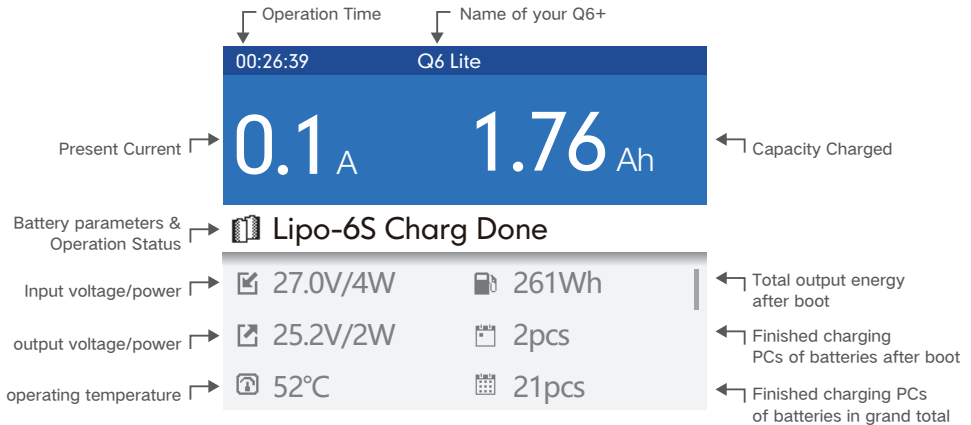

Precise Balance Charging

System Default

Long press the shuttle key in standby interface to make the system default menu pop up, and the items are as follows:

Max Input Power	Limited between 50 - 230 W
Min Input Voltage	Limited between 7 - 24 V
Backlight	Three gears: high, medium, low, Automatic
Volume	Three gears: high, medium, low; and off
About	See system software information
Save	Save altered system default items
Cancel	Cancel all alteration and exit system default menu

Max input power limitation: if the input power fails to reach the max working power (160W), set this parameter based on the actual output capacity of input power in order to protect it and enable the charger to work stably. For example, as the power connected is 12V/10A, the value of this item should be 120W.

Min input power: this item can protect the battery from excessive discharge since it's used as input power. If the charger tests that the input voltage is lower than the default value, all tasked in operation would be terminated and there would be a warning of low voltage. For example, if a 6S Lipo battery is used as the input power source, the value of the item should be 21V to protect the battery from excessive discharge.

Buzzer volume: the default is OFF, the operation sound would be blocked, but not the sound of error warning.

Troubleshoot

- Error in power on self-testing: the charger can automatically carry out a self-testing when connected to a power supply. A self-testing error warning sound should be heard when the charger is connected to the battery; power on after removing the battery for 5 minutes.
- Error for abnormal battery connection: pull out and plug in the battery again to ensure all connections are reliably contacted; if the error reminder continues, please check whether the metal parts on the battery interface are oxidized or burned resulting in unreliable connection.
- Error for unstable power voltage: check whether the battery socket is reliably connected, and whether the power of electric supply can match the input requirement of the charger. If the power is smaller than 160 W, please adjust the max input power to match the power of electric supply in the system fault menu of the charger.

Product Qualification Declaration

This smart charger conforms to relevant EC command and relevant commands in B: 2010, CHAPTER 15, FCC

Testing standards	Result
EN 55014-1:2006+ A1:2009+A2:2011	YES
EN 55014-2:1997+ A1:2001+A2:2008	YES



For electronic products with this marking in their manuals, please separately dispose them with family garbage. When a charger gets spoilt and cannot be used anymore, please take it to a nearby garbage station or recycle center.



WWW.ISDT.CO

Manufacturer

Shenzhen ISD Technology CO.,LTD

Address: 5th Fl., Bldg. 9, Mabian Industrial Zone, Yangtian Rd.,
Block 72, Xin'An Street, Bao'An District, Shenzhen, PRC



Email:hi@isdt.co

Changes in specifications and data will not be further noticed.